

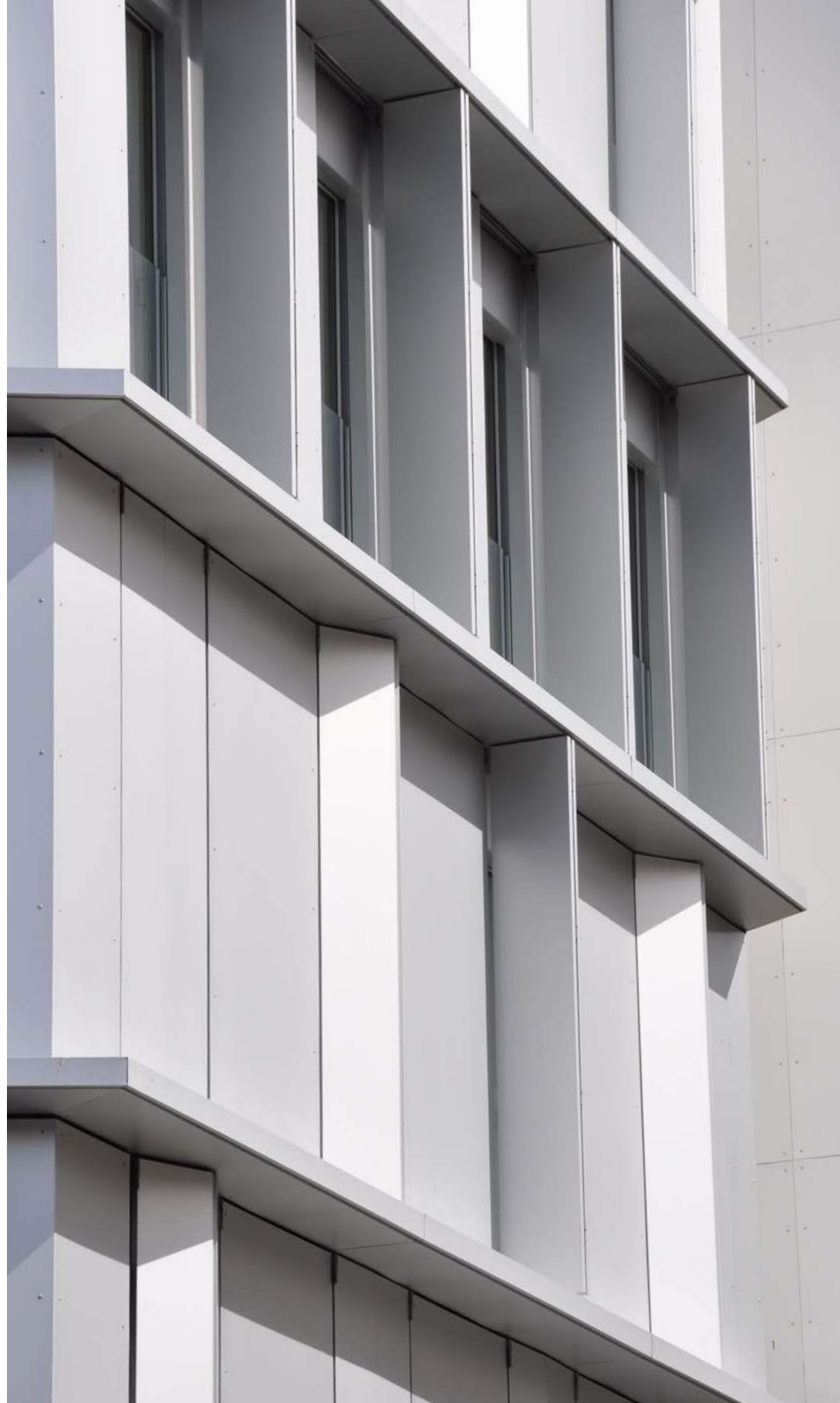

# SHUTTER HARDWARE

rob

OPENING DOORS





## ARLU, THE REFERENCE FOR OPENING DOORS

ARLU® is the manufacturer behind the argenta® and rob® brand names. Rob has been a pioneering brand in outdoor hardware for more than 80 years.

Throughout its history, it has invariably focused on offering a complete range of technologies to effortlessly open and close doors and shutters of all shapes and sizes, across their entire lifespan.

Whether your doors slide, fold or tilt, flawless movement starts with reliable hardware. If that hardware can be designed to be fully integrated and as unobtrusive as possible, this only contributes to an unparalleled tillal experience that perfectly combines looks and user comfort.

Rob stands for a complete range of durable outdoor hardware.

ALL TECHNICAL DRAWINGS ARE SHOWN IN MILLIMETRES AND ARE SUBJECT TO CHANGE BY ARLU.

# 01

## STRAIGHT-SLIDING SHUTTERS

Rob's hardware enables straight-sliding shutters to move more smoothly than ever. Every series is made to operate shutters within its own weight category in the best possible way. Shutters of 40, 80, or 120 kg are fitted with an aluminium track with cover options. Combining a smooth aluminium profile with UPVC wheels on ball bearings, ensures silent operation. A stainless steel variant provides a safe and secure solution to move the heavier shutters up to 180 kg. The A-slide automation ensures ease of use during installation and application

### 01

#### STRAIGHT-SLIDING SHUTTERS

- 6 sliding shutters
- 28 symmetrical sliding shutters
- 34 telescopic sliding shutters

### 02

#### FOLDING SHUTTER HARDWARE

- 46 folding shutters 20 kg
- 56 folding shutters 40 kg

### 03

#### HINGED SHUTTER FITTINGS

- 70 hinges
- 73 pintels
- 75 shutter dogs
- 76 bolts
- 77 stable rings

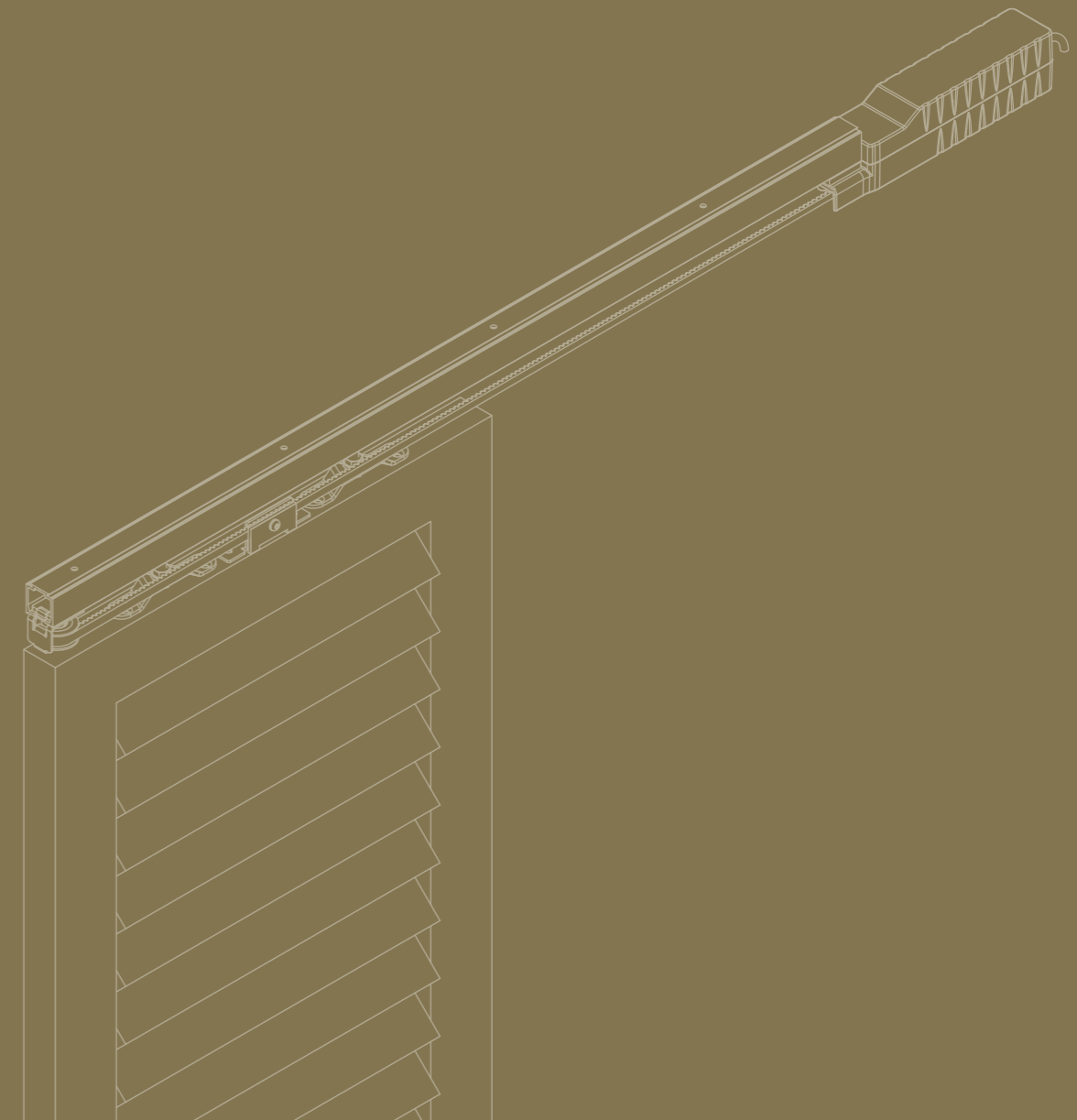

straight-sliding shutters  
general information

Aluminium, timber and PVC

Straight-sliding shutter hardware can be used to slide single, symmetrical or telescopic shutters of various weights, manually or automatically. A wind permeability of at least 50% is required. The maximum surface area must always be respected. If these requirements are met, the hardware complies with the NBN B 03-002-1 standard (wind load on buildings). The quality of this hardware guarantees at least 100,000 cycles.

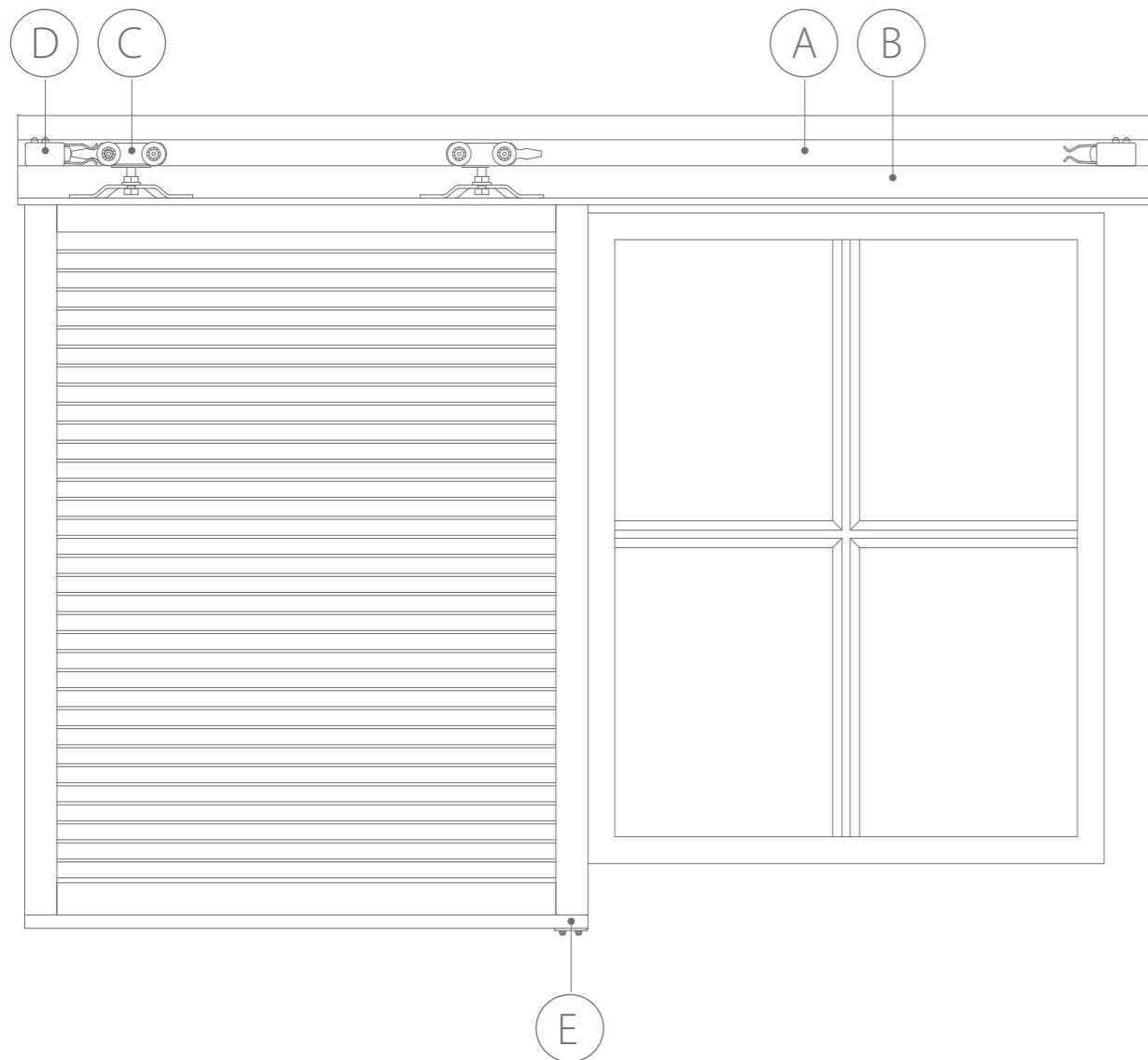

**A** Running tracks are available for weights of up to 40, 80, or 120 kg per panel. They have bevelled sides that ensure smooth and centred movement of the roller system. All aluminium running tracks are anodised, which makes the running surface even smoother and prevents corrosion. Tracks fit for ceiling mounting all come with pre-drilled holes. For wall-mounted systems, this can be combined with multiple wall brackets. For heavy shutters of up to 180 kg, a stainless steel running track is available that can be mounted to the façade using wall or ceiling brackets.

**B** All hardware is neatly hidden with cover profiles. These untreated aluminium profiles must be removed from their packaging and processed immediately upon receipt to prevent oxidation.

**C** All roller systems are fitted on ball bearings reducing any resistance and allowing each shutter to open with minimal effort. The 80 kg Superior rollers and the heavier 120 kg and 180 kg versions come with one ball bearing per wheel. All random parts are made of AISI 304 stainless steel.

**D** Just like the roller system, the stopper is a core element of a sliding shutter. When it reaches its end position, the tip of the roller latches into the clamp on the stopper. The stopper catches the shutter and keeps it in position. It can easily be positioned, and the clamp force can be adjusted if necessary. Only the 180 kg version runs into a stopper fitted with rubber and without hold position.

**E** A guide channel is used to keep the shutter at a perfect right angle while moving. Several options are available, but in all cases, a guiding channel limits the maximum surface area of the shutter to 3 m<sup>2</sup>. This surface area can be increased by guiding the shutter through multiple connected channels – feel free to contact us for more information.

**F** The stoppers determine the end positions of the shutters, but they need an additional locking system to hold the shutters firmly in place in their positions. This prevents the shutter from moving and makes it wind-resistant. If a shutter is not locked into place, the wind may cause it to bash against the stoppers too quickly and strongly, which may lead to damage.

\* Any warranty will lapse if the proposed setup and the components used therein are deviated from.



rob

## **STRAIGHT-SLIDING SHUTTER HARDWARE** 40 - 180 KG

The shutter can be mounted under the lintel or upon the wall, providing a suitable solution for every situation. With the right choice of bottom guiding system, shutter installations can be expanded from a maximum of 3 m<sup>2</sup> to a maximum of 6 m<sup>2</sup>. Shutters can be automated for even greater ease of use. What's more, this automation makes it possible to operate the shutters without any need to be able to open the window.

Technical drawing

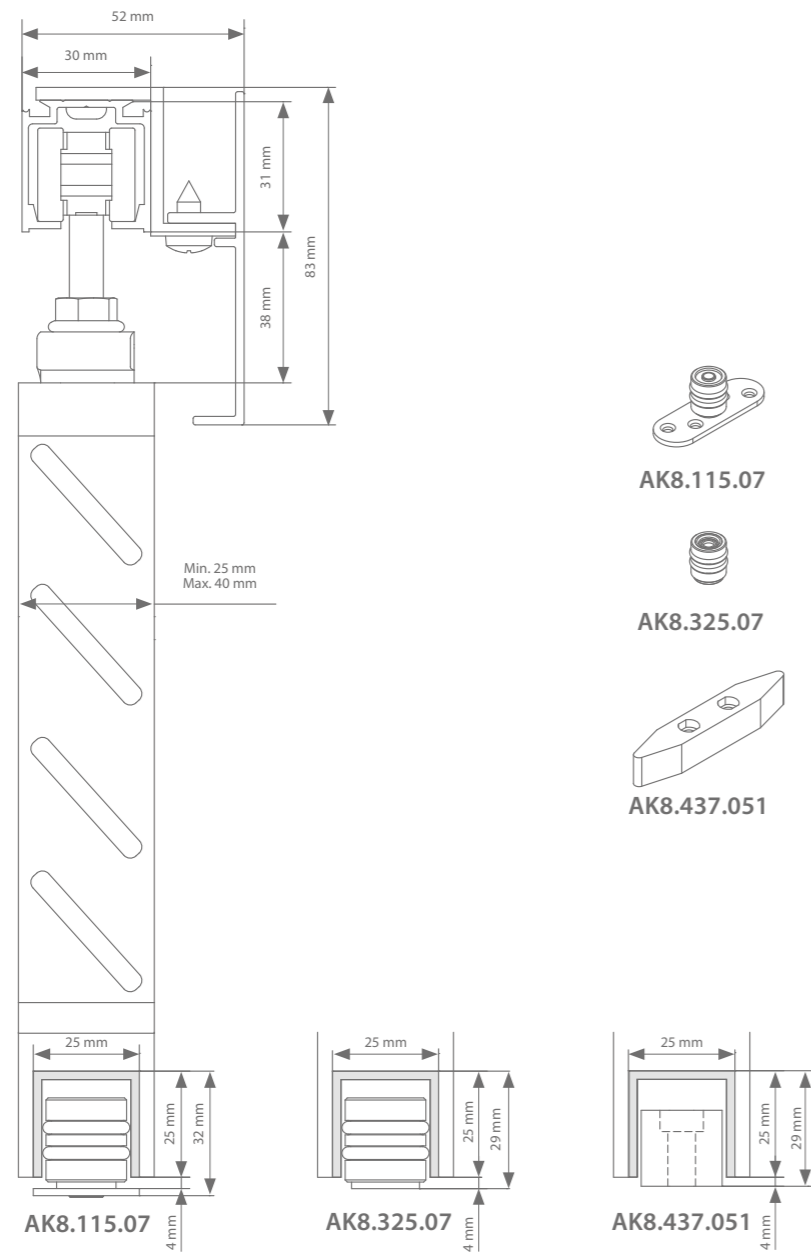

Product requirements

Shutter weight	Max. 40 kg per panel
Wind permeability	Min. 50 %
Surface area	Max. 6m <sup>2</sup> with an additional guiding system
Height adjustment	+ / - 3 mm

Profiles

	Max. shutter width	Length	Article number
<b>Running track</b> (grey anodised aluminium)	1000 mm	2000 mm	AG0.208.200
	1500 mm	3000 mm	AG0.208.300
	2000 mm	4000 mm	AG0.208.400
	3000 mm	6000 mm	AG0.208.600
<b>Cover profile</b> (untreated aluminium)	1000 mm	2000 mm	AG9.938.200
	1500 mm	3000 mm	AG9.938.300
	2000 mm	4000 mm	AG9.938.400
	3000 mm	6000 mm	AG9.938.600
<b>+ mounting bracket for cover profile</b>	Required every 480 mm		AG1.138.1
<b>+ set of screws</b>	Required every 3000 mm		AG1.128.300.9

Floor-mounted guiding system

<b>Guiding track</b> (untreated aluminium)	1000 mm	1000 mm	AK0.618.100
	2000 mm	2000 mm	AK0.618.200
	3000 mm	3000 mm	AK0.618.300
	4000 mm	4000 mm	AK0.618.400
	6000 mm	6000 mm	AK0.618.600
<b>Guiding system options</b>	1x required up to shutter surface area of 3 m <sup>2</sup>		AK8.115.07
			AK8.325.07
	2x required up to shutter surface area of 6 m <sup>2</sup>		AK8.437.051

Manual gear

Suspension	Transverse suspension	Article number
Fittings (min. shutter width = 315 mm)	Set incl. 2 rollers, 2 stoppers, and 2 support plates	AG0.100.004

Technical drawing

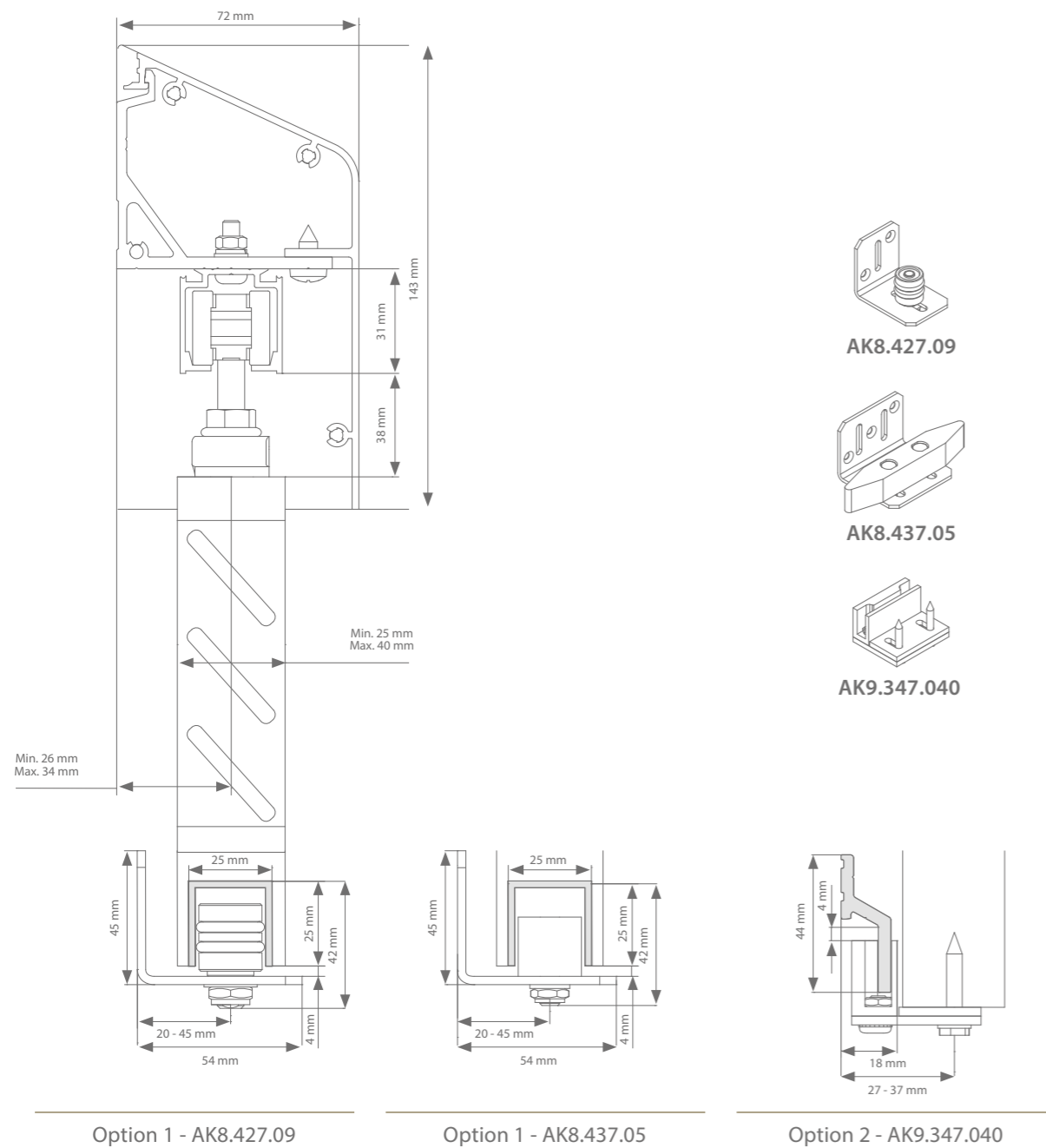

Product requirements

Shutter weight	Max. 40 kg per panel
Wind permeability	Min. 50 %
Surface area	Max. 6m <sup>2</sup> with an additional guiding system
Height adjustment	+ / - 3 mm

Profiles

	Max. shutter width	Length	Article number
Running track (grey anodised aluminium)	1000 mm	2000 mm	AG0.208.200
	1500 mm	3000 mm	AG0.208.300
	2000 mm	4000 mm	AG0.208.400
	3000 mm	6000 mm	AG0.208.600
End wall bracket (untreated aluminium)	2x required		AG1.128.1
Middle wall bracket (untreated aluminium)	Required every 480 mm		AG1.128.2
Cover profile (untreated aluminium)	1000 mm	2000 mm	AG9.928.200
	1500 mm	3000 mm	AG9.928.300
	2000 mm	4000 mm	AG9.928.400
	3000 mm	6000 mm	AG9.928.600
+ set of end caps	1x required		AK9.928
+ set of screws	Required every 3000 mm		AG1.128.300.9

Wall-mounted guiding system option 1

Guiding track (untreated aluminium)	1000 mm	1000 mm	AK0.618.100
	2000 mm	2000 mm	AK0.618.200
	3000 mm	3000 mm	AK0.618.300
	4000 mm	4000 mm	AK0.618.400
	6000 mm	6000 mm	AK0.618.600
Guiding system options	1x required up to shutter surface area of 3 m <sup>2</sup>		AK8.427.09
	2x required up to shutter surface area of 6 m <sup>2</sup>		AK8.437.05

Wall-mounted guiding system option 2

Guiding track (untreated aluminium)	1000 mm	2000 mm	AK9.340.200
	1500 mm	3000 mm	AK9.340.300
	2000 mm	4000 mm	AK9.340.400
	3000 mm	6000 mm	AK9.340.600
Guiding system options	2x required up to shutter surface area of 3 m <sup>2</sup>		AK9.347.040
	4x required up to shutter surface area of 6 m <sup>2</sup>		

Manual gear

Suspension	Transverse suspension	Article number
Fittings (min. shutter width = 315 mm)	Set incl. 2 rollers, 2 stoppers, and 2 support plates	AG0.100.004

Technical drawing

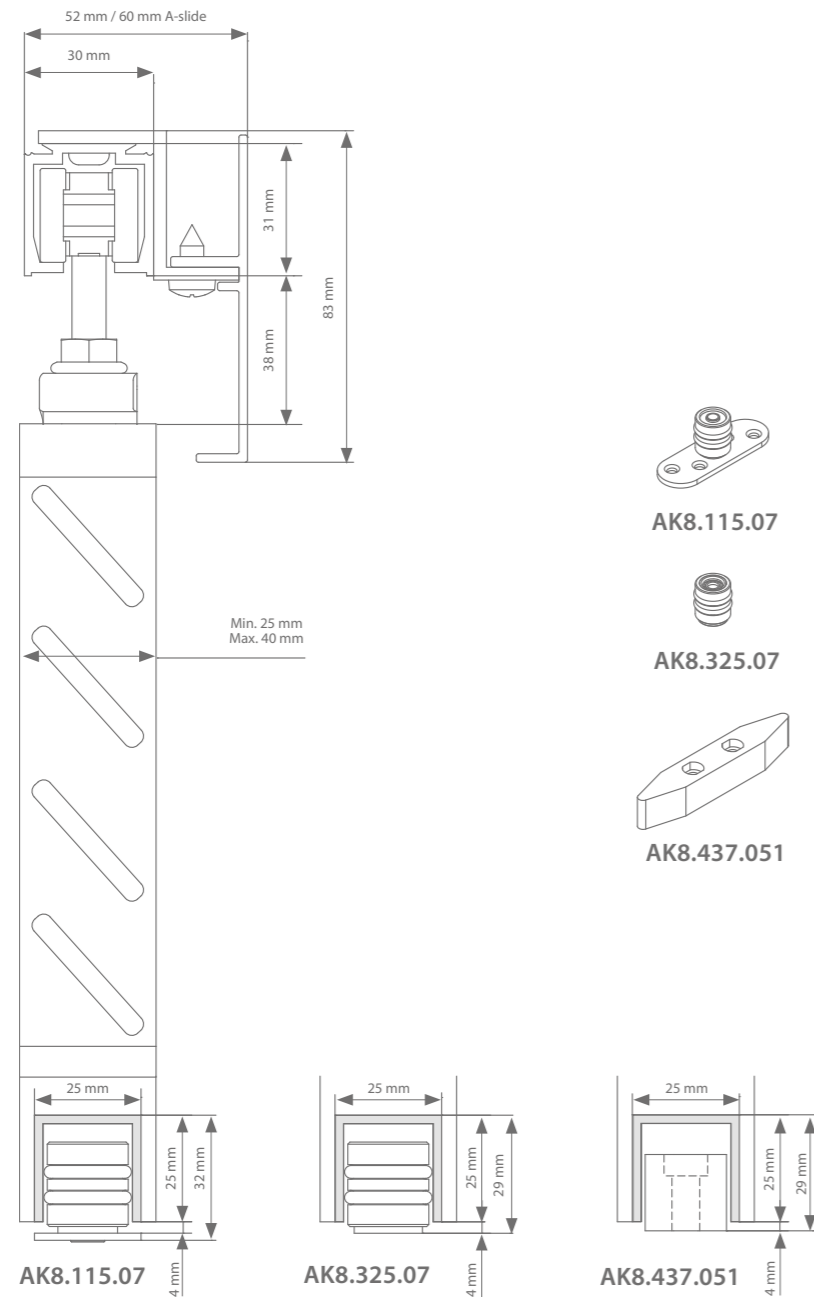

Product requirements

Shutter weight	Max. 80 kg per panel
Wind permeability	Min. 50 %
Surface area	Max. 6m <sup>2</sup> with an additional guiding system
Height adjustment	+ / - 3 mm

Profiles

	Max. shutter width	Length	Article number
Running track (grey anodised aluminium)	1000 mm	2000 mm	AK0.208.200
	1500 mm	3000 mm	AK0.208.300
	2000 mm	4000 mm	AK0.208.400
	3000 mm	6000 mm	AK0.208.600
Cover profile (untreated aluminium)	1000 mm	2000 mm	AG9.938.200
	1500 mm	3000 mm	AG9.938.300
	2000 mm	4000 mm	AG9.938.400
	3000 mm	6000 mm	AG9.938.600
+ mounting bracket for cover profile	Required every 480 mm		AG1.138.1 AG1.137.2 (with A-slide)
+ set of screws	Required every 3000 mm		AG1.128.300.9

Floor-mounted guiding system

Guiding track (untreated aluminium)	1000 mm	1000 mm	AK0.618.100
	2000 mm	2000 mm	AK0.618.200
	3000 mm	3000 mm	AK0.618.300
	4000 mm	4000 mm	AK0.618.400
	6000 mm	6000 mm	AK0.618.600
Guiding system options	1x required up to shutter surface area of 3 m <sup>2</sup>		AK8.115.07
			AK8.325.07
	2x required up to shutter surface area of 6 m <sup>2</sup>		AK8.437.051

Manuel gear

Suspension	Transverse suspension	Article number
Fittings (min. shutter width = 315 mm)	Set incl. 2 rollers, 2 stoppers, and 2 support plates	AK0.100.044
	Superior Set incl. 2 rollers, 2 stoppers, and 2 support plates	AK0.100.004

A-slide gear

Suspension	Transverse suspension with motor	Article number
Fittings (min. shutter width = 500 mm, motor above shutter = 720 mm)	Superior set with 2 rollers, 2 stoppers, 2 support plates, carrier, reverse pulley and motor	AK3.100.004
	Min. belt length in metres = (4 x shutter width) + 200 mm	(no. of metres) x AK9.709.001
Remote control	for 1 channel	AM3.100.104.61
	for 4 channels	AM3.100.104.64

Technical drawing

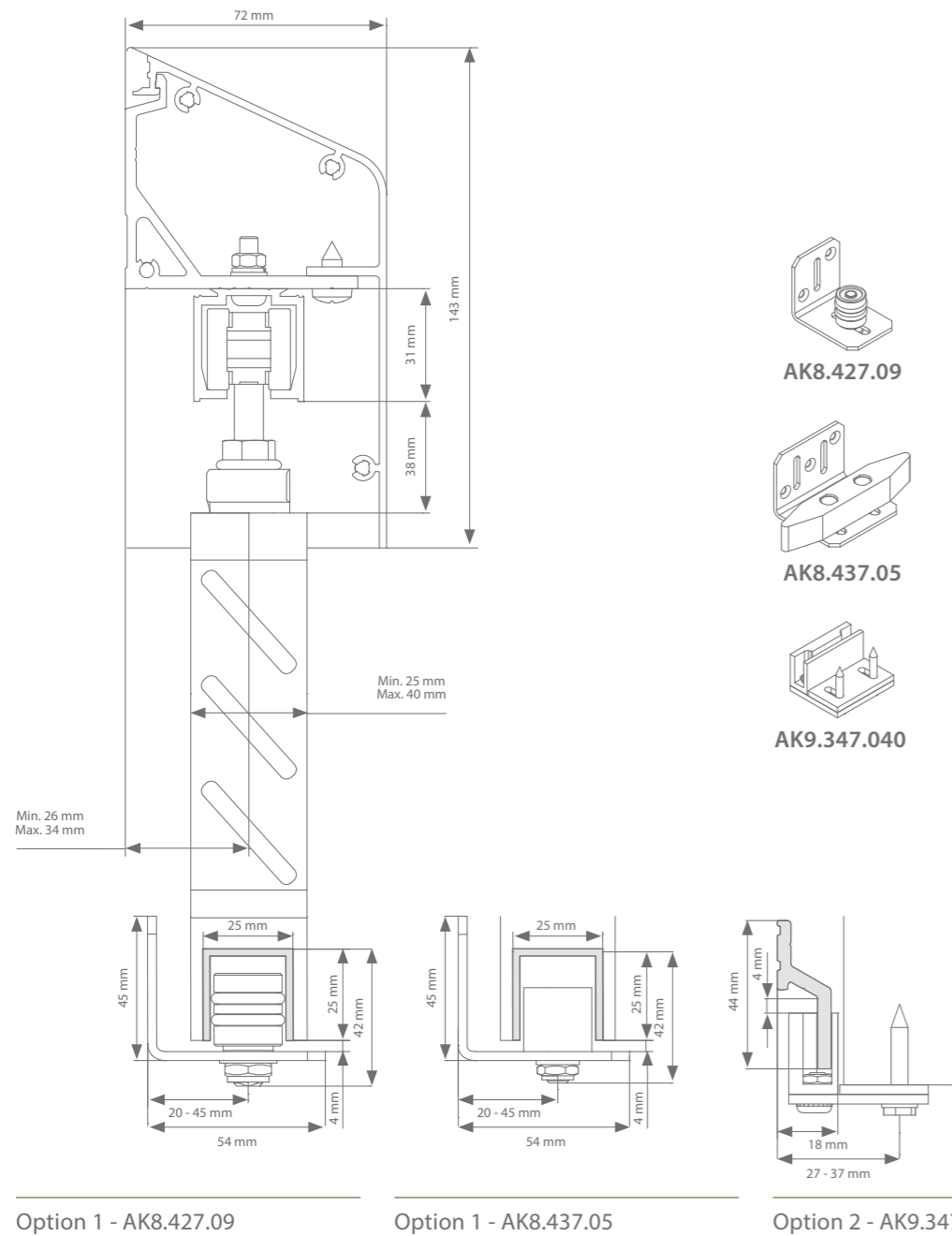

Product requirements

Shutter weight	Max. 80 kg per panel
Wind permeability	Min. 50 %
Surface area	Max. 6m <sup>2</sup> with an additional guiding system
Height adjustment	+ / - 3 mm

Profiles

	Max. shutter width	Length	Article number
Running track (grey anodised aluminium)	1000 mm	2000 mm	AK0.208.200
	1500 mm	3000 mm	AK0.208.300
	2000 mm	4000 mm	AK0.208.400
	3000 mm	6000 mm	AK0.208.600
End wall bracket (untreated aluminium)	2x required		AG1.128.1*
Middle wall bracket (untreated aluminium)	Required every 480 mm		AG1.128.2*
Cover profile (untreated aluminium)	1000 mm	2000 mm	AG9.928.200
	1500 mm	3000 mm	AG9.928.300
	2000 mm	4000 mm	AG9.928.400
	3000 mm	6000 mm	AG9.928.600
+ set of end caps	1x required		AK9.928
+ set of screws	Required every 3000 mm		AG1.128.300.9

Wall-mounted guiding system option 1

Guiding track (untreated aluminium)	1000 mm	1000 mm	AK0.618.100
	2000 mm	2000 mm	AK0.618.200
	3000 mm	3000 mm	AK0.618.300
	4000 mm	4000 mm	AK0.618.400
	6000 mm	6000 mm	AK0.618.600
Guiding system options	1x required up to shutter surface area of 3 m <sup>2</sup>		AK8.427.09
	2x required up to shutter surface area of 6 m <sup>2</sup>		AK8.437.05

Wall-mounted guiding system option 2

Guiding track (untreated aluminium)	1000 mm	2000 mm	AK9.340.200
	1500 mm	3000 mm	AK9.340.300
	2000 mm	4000 mm	AK9.340.400
	3000 mm	6000 mm	AK9.340.600
Guiding system options	2x required up to shutter surface area of 3 m <sup>2</sup> / 4x required up to shutter surface area of 6 m <sup>2</sup>		AK9.347.040

Manual gear

Suspension	Transverse suspension	Article number
Fittings (min. shutter width = 315 mm)	Set incl. 2 rollers, 2 stoppers, and 2 support plates	AK0.100.044
	Superior Set incl. 2 rollers, 2 stoppers, and 2 support plates	AK0.100.004

A-slide gear

Suspension	Transverse suspension with motor	Article number
Fittings (min. shutter width = 500 mm, motor above shutter = 720 mm)	Superior set with 2 rollers, 2 stoppers, 2 support plates, carrier, reverse pulley and motor	AK3.100.004
	Min. belt length in metres = (4 x shutter width) + 200 mm	(aantal meter) x AK9.709.001
Remote control	for 1 channel	AM3.100.104.61
	for 4 channels	AM3.100.104.64

\* Wall bracket AK1.917 does not require a cover profile.

## Technical drawing

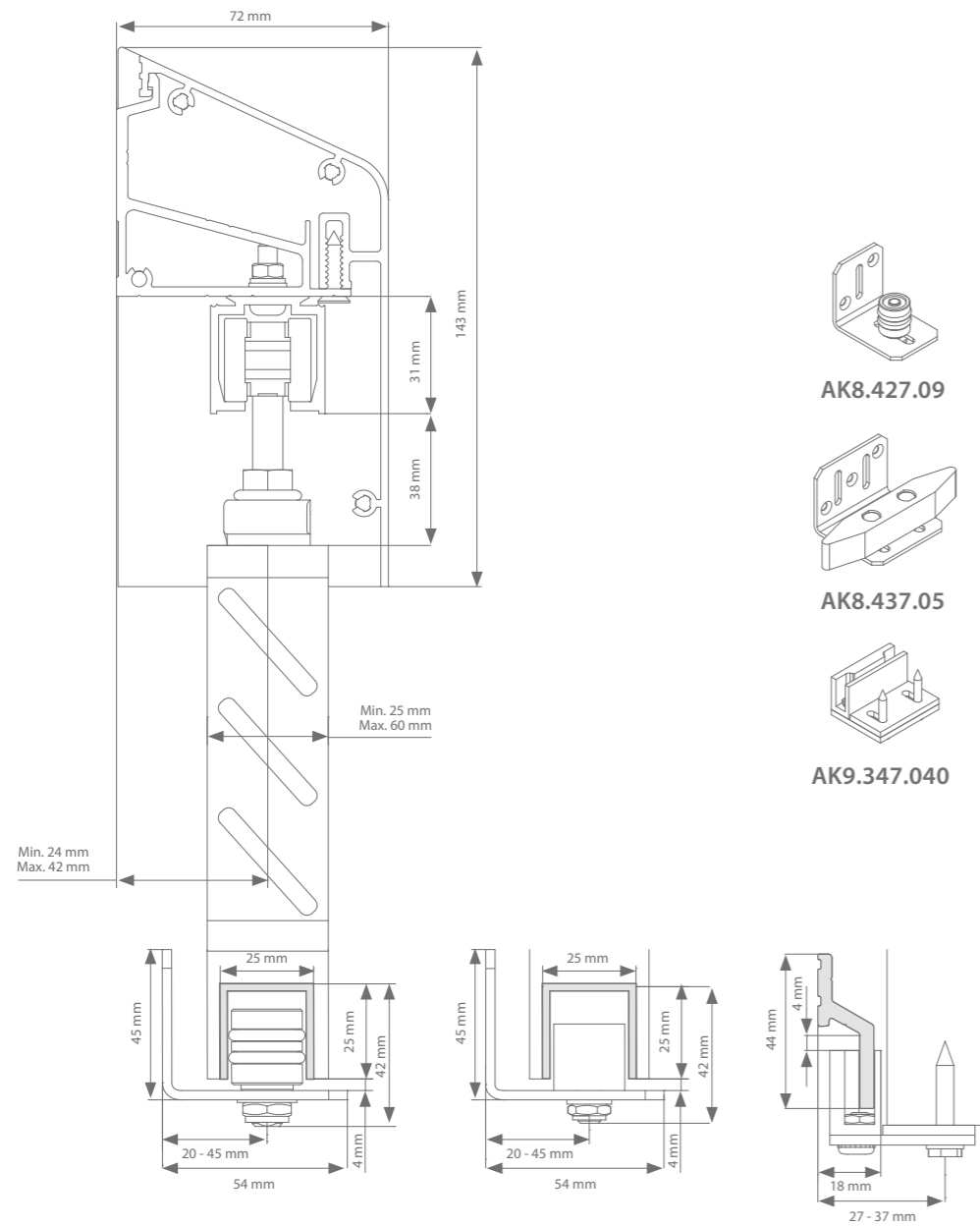

Option 1 - AK8.427.09

Option 1 - AK8.437.05

Option 2 - AK9.347.040

## Product requirements

Shutter weight	Max. 80 kg per panel
Wind permeability	Min. 50 %
Surface area	Max. 6m <sup>2</sup> with an additional guiding system
Height adjustment	+ / - 3 mm

## Advantages

The main advantage of a support profile is that it facilitates quicker installation compared to measuring and positioning every wall bracket.

## Profiles

	Max. shutter width	Length	Article number
<b>Running track</b> (grey anodised aluminium)	1000 mm	2000 mm	AK0.208.200
	1500 mm	3000 mm	AK0.208.300
	2000 mm	4000 mm	AK0.208.400
	3000 mm	6000 mm	AK0.208.600
<b>Support profile</b> (untreated aluminium)	1000 mm	2000 mm	AK1.128.200
	1500 mm	3000 mm	AK1.128.300
	2000 mm	4000 mm	AK1.128.400
	3000 mm	6000 mm	AK1.128.600
<b>Cover profile</b> (untreated aluminium)	1000 mm	2000 mm	AK9.928.200
	1500 mm	3000 mm	AK9.928.300
	2000 mm	4000 mm	AK9.928.400
	3000 mm	6000 mm	AK9.928.600
+ set of end caps	1x required		AK9.928
+ set of screws	Required every 3000 mm		AK1.128.300.9

## Wall-mounted guiding system option 1

<b>Guiding track</b> (untreated aluminium)	1000 mm	1000 mm	AK0.618.100
	2000 mm	2000 mm	AK0.618.200
	3000 mm	3000 mm	AK0.618.300
	4000 mm	4000 mm	AK0.618.400
	6000 mm	6000 mm	AK0.618.600
<b>Guiding system options</b>	1x required up to shutter surface area of 3 m <sup>2</sup>		AK8.427.09
	2x required up to shutter surface area of 6 m <sup>2</sup>		AK8.437.05

## Wall-mounted guiding system option 2

<b>Guiding track</b> (untreated aluminium)	1000 mm	2000 mm	AK9.340.200
	1500 mm	3000 mm	AK9.340.300
	2000 mm	4000 mm	AK9.340.400
	3000 mm	6000 mm	AK9.340.600
<b>Guiding system options</b>	2x required up to shutter surface area of 3 m <sup>2</sup> / 4x required up to shutter surface area of 6 m <sup>2</sup>		AK9.347.040

## Manual gear

Suspension	Transverse suspension	Article number
Fittings (min. shutter width = 315 mm)	Set incl. 2 rollers, 2 stoppers, and 2 support plates	AK0.100.044
	Superior Set incl. 2 rollers, 2 stoppers, and 2 support plates	AK0.100.004

## A-slide gear

Suspension	Transverse suspension with motor	Article number
Fittings (min. shutter width = 500 mm, motor above shutter = 720 mm)	Superior set with 2 rollers, 2 stoppers, 2 support plates, carrier, reverse pulley and motor	AK3.100.004
	Min. belt length in metres = (4 x shutter width) + 200 mm	(aantal meter) x AK9.709.001
Remote control	for 1 channel	AM3.100.104.61
	for 4 channels	AM3.100.104.64

Technical drawing

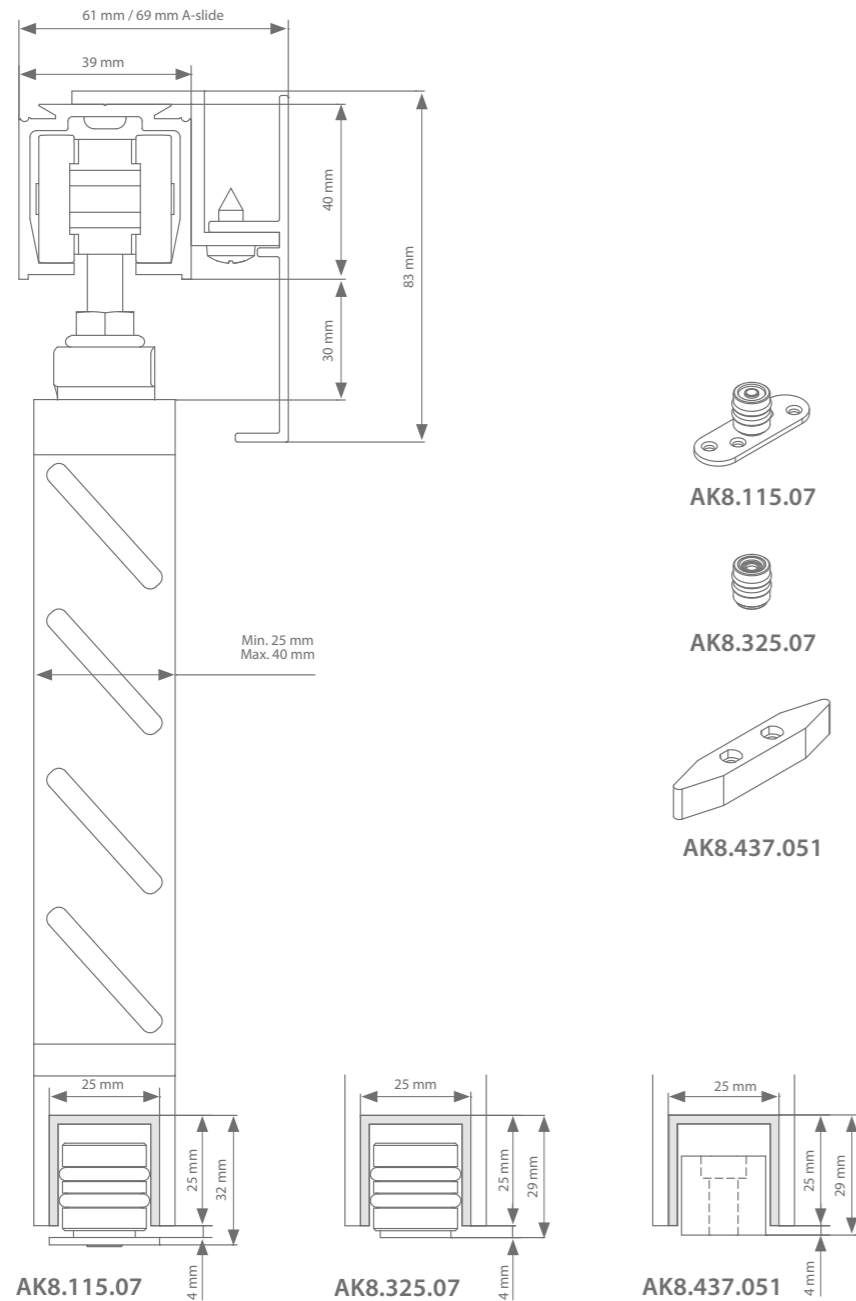

Product requirements

Shutter weight	Max. 120 kg per panel
Wind permeability	Min. 50 %
Surface area	Max. 6m <sup>2</sup> with an additional guiding system
Height adjustment	+ / - 3 mm

Profiles

	Max. shutter width	Length	Article number
Running track (grey anodised aluminium)	1000 mm	2000 mm	AM0.208.200
	1500 mm	3000 mm	AM0.208.300
	2000 mm	4000 mm	AM0.208.400
	3000 mm	6000 mm	AM0.208.600
Cover profile (untreated aluminium)	1000 mm	2000 mm	AG9.938.200
	1500 mm	3000 mm	AG9.938.300
	2000 mm	4000 mm	AG9.938.400
	3000 mm	6000 mm	AG9.938.600
+ mounting bracket for cover profile	Required every 480 mm		AG1.138.1 AG1.137.2 (with A-slide)
+ set of screws	Required every 3000 mm		AG1.128.300.9

Floor-mounted guiding system

Guiding track (untreated aluminium)	1000 mm	1000 mm	AK0.618.100
	2000 mm	2000 mm	AK0.618.200
	3000 mm	3000 mm	AK0.618.300
	4000 mm	4000 mm	AK0.618.400
	6000 mm	6000 mm	AK0.618.600
Guiding system options	1x required up to shutter surface area of 3 m <sup>2</sup>		AK8.115.07
			AK8.325.07
	2x required up to shutter surface area of 6 m <sup>2</sup>		AK8.437.051

Manual gear

Suspension	Transverse suspension	Article number
Fittings (min. shutter width = 335 mm)	Set incl. 2 rollers, 2 stoppers, and 2 support plates	AM0.100.004

A-slide gear

Suspension	Transverse suspension with motor	Article number
Fittings (min. shutter width = 520 mm, motor above shutter = 740 mm)	Superior set with 2 rollers, 2 stoppers, 2 support plates, carrier, reverse pulley and motor	AM3.100.004
	Min. belt length in metres = (4 x shutter width) + 200 mm	(no. of metres) x AK9.709.001
Remote control	for 1 channel	AM3.100.104.61
	for 4 channels	AM3.100.104.64

Technical drawing

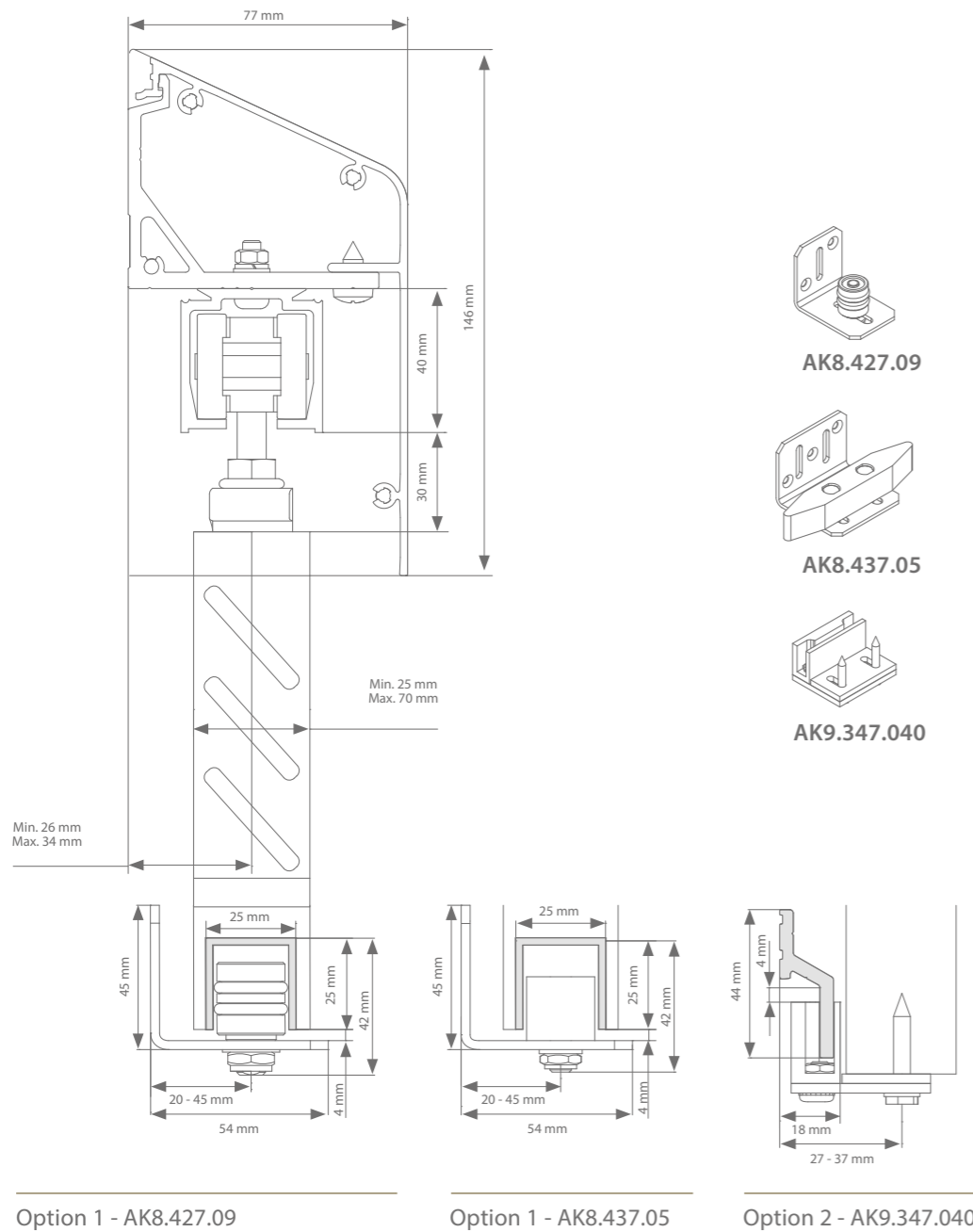

Option 1 - AK8.427.09

Option 1 - AK8.437.05

Option 2 - AK9.347.040

Product requirements

Shutter weight	Max. 120 kg per panel
Wind permeability	Min. 50 %
Surface area	Max. 6m <sup>2</sup> with an additional guiding system
Height adjustment	+ / - 3 mm

Profiles

	Max. shutter width	Length	Article number
Running track (grey anodised aluminium)	1000 mm	2000 mm	AM0.208.200
	1500 mm	3000 mm	AM0.208.300
	2000 mm	4000 mm	AM0.208.400
	3000 mm	6000 mm	AM0.208.600
End wall bracket (untreated aluminium)	2x required		AM1.128.1
Middle wall bracket (untreated aluminium)	Required every 480 mm		AM1.128.2
Cover profile (untreated aluminium)	1000 mm	2000 mm	AM9.928.200
	1500 mm	3000 mm	AM9.928.300
	2000 mm	4000 mm	AM9.928.400
	3000 mm	6000 mm	AM9.928.600
+ set of end caps	1x required		AM9.928
+ set of screws	Required every 3000 mm		AG1.128.300.9

Wall-mounted guiding system option 1

Guiding track (untreated aluminium)	1000 mm	1000 mm	AK0.618.100
	2000 mm	2000 mm	AK0.618.200
	3000 mm	3000 mm	AK0.618.300
	4000 mm	4000 mm	AK0.618.400
	6000 mm	6000 mm	AK0.618.600
Guiding system options	1x required up to shutter surface area of 3 m <sup>2</sup>		AK8.427.09
	2x required up to shutter surface area of 6 m <sup>2</sup>		AK8.437.05

Manual gear

Suspension	Transverse suspension	Article number
Fittings (min. shutter width = 335 mm)	Set incl. 2 rollers, 2 stoppers, and 2 support plates	AM0.100.004

A-slide gear

Suspension	Transverse suspension with motor	Article number
Fittings (min. shutter width = 520 mm, motor above shutter = 740 mm)	Superior set with 2 rollers, 2 stoppers, 2 support plates, carrier, reverse pulley and motor	AM3.100.004
	Min. belt length in metres = (4 x shutter width) + 200 mm	(no. of metres) x AK9.709.001
Remote control	for 1 channel	AM3.100.104.61
	for 4 channels	AM3.100.104.64

Technical drawing

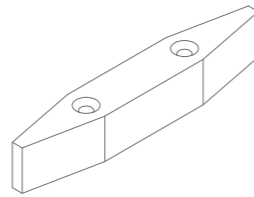
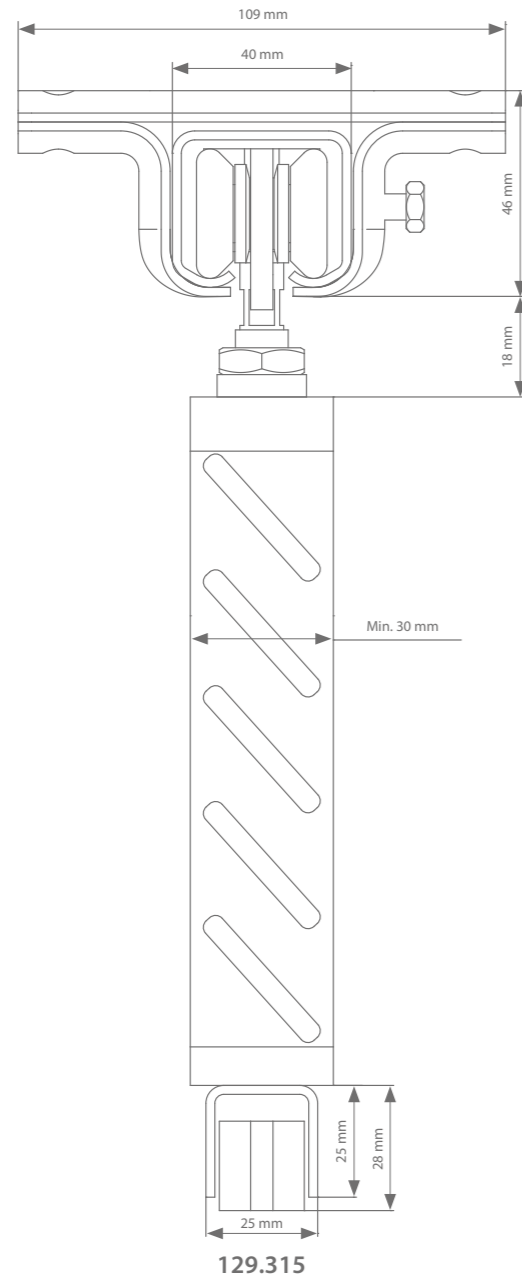

129.315

129.315

Product requirements

Shutter weight	Max. 180 kg per panel
Wind permeability	Min. 50 %
Surface area	Max. 6m <sup>2</sup> with an additional guiding system
Height adjustment	+ / - 3 mm

Profiles

	Max. shutter width	Length	Article number
Running track (stainless steel)	1000 mm	2000 mm	120.007.200
	1500 mm	3000 mm	120.007.300
	2000 mm	4000 mm	120.007.400
	3000 mm	6000 mm	120.007.600
End lintel bracket (stainless steel)	2x required		121.227
Middle lintel bracket (stainless steel)	Required every 600 mm		121.217

Floor-mounted guiding system

Guiding track (untreated aluminium)	2000 mm	2000 mm	120.607.200
	3000 mm	3000 mm	120.607.300
	4000 mm	4000 mm	120.607.400
	6000 mm	6000 mm	120.607.600
Guiding channel	1x required up to shutter surface area of 6 m <sup>2</sup>		129.315

Fittings

Stainless steel roller	2x required	124.257 (with steel bearings) 124.257.02 (with stainless steel bearings)
Stainless steel stopper	2x required	129.617
Stainless steel support plate	2x required	127.617

Technical drawing

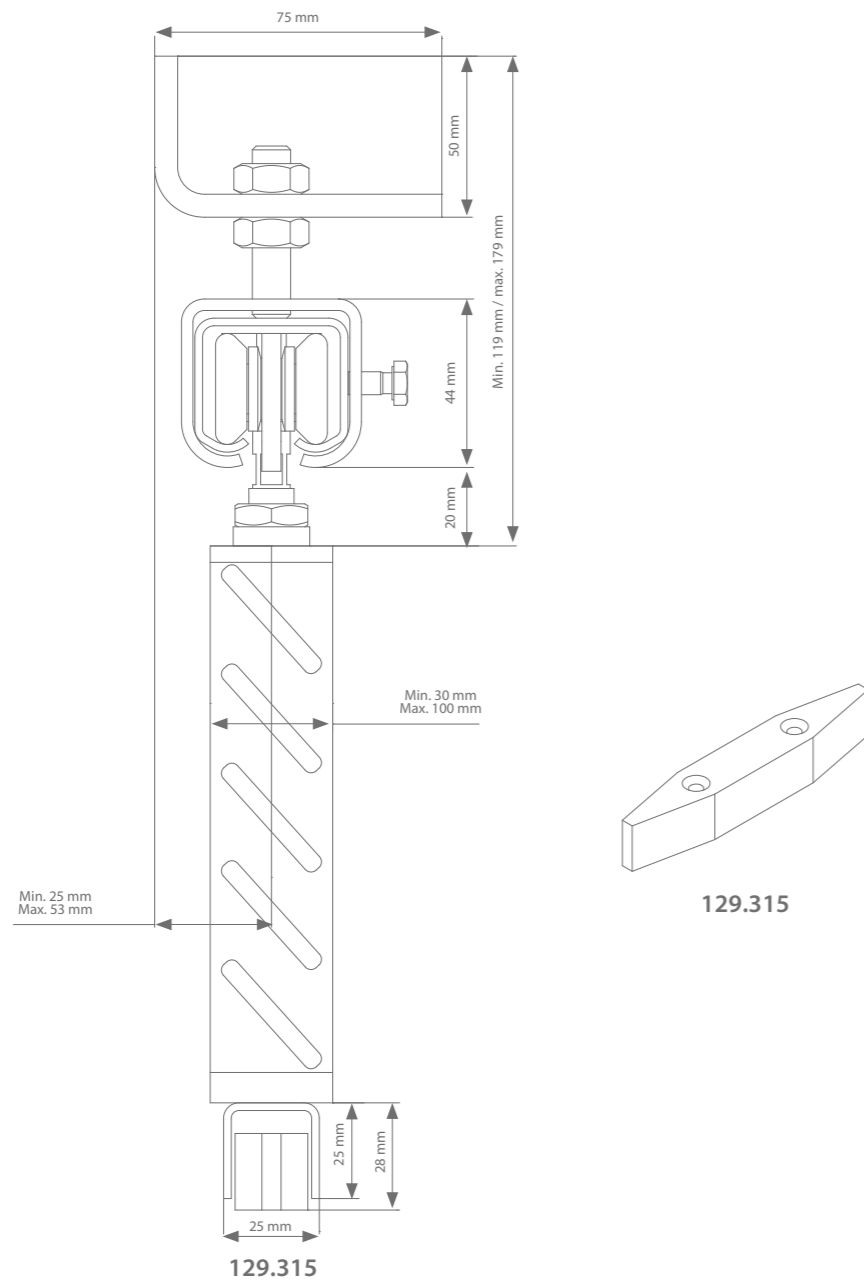

Product requirements

Shutter weight	Max. 180 kg per panel
Wind permeability	Min. 50 %
Surface area	Max. 6m <sup>2</sup> with an additional guiding system
Height adjustment	+ / - 3 mm

Profiles

	Max. shutter width	Length	Article number
Running track (stainless steel)	1000 mm	2000 mm	120.007.200
	1500 mm	3000 mm	120.007.300
	2000 mm	4000 mm	120.007.400
	3000 mm	6000 mm	120.007.600
Threaded joint bracket (stainless steel)	2x required		121.327
Threaded bracket (stainless steel)	Required every 600 mm		121.317
Angle	Required for every bracket		121.917

Wall-mounted guiding system option 1

Guiding track (untreated aluminium)	2000 mm	2000 mm	120.607.200
	3000 mm	3000 mm	120.607.300
	4000 mm	4000 mm	120.607.400
	6000 mm	6000 mm	120.607.600
Guiding channel	1x required up to shutter surface area of 6 m <sup>2</sup>		129.315

Fittings

Stainless steel roller	2x required	124.257 (with steel bearings) 124.257.02 (with stainless steel bearings)
Stainless steel stopper	2x required	129.617
Stainless steel support plate	2x required	127.617



## a-slide automatisation

Right-sliding, symmetrical, or telescopic shutters can be automated using our motor, the A-slide Exterior. To automate sliding shutters, we use a belt that moves between the reversing wheels and the motor. A carrier links this belt to the shutter. The A-slide is tested with shutters up to 120 kg and has an electronic brake that can be switched on to prevent the shutters from blowing open.

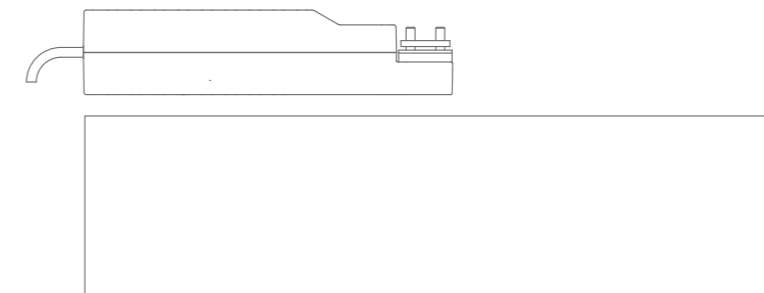

DOWNLOAD APP

The A-slide is a smart motor that learns itself when first used. Thanks to the handy app, the motor can be further configured via Bluetooth or Wi-Fi. Afterwards, the user can determine the position and speed of the shutters remotely via the app. The A-slide motor can also be operated with a switch or a remote control.

Max. weight	120 kg
Movement	Straight-sliding Symmetrical Telescopic
Remote controls	Switch 1- or 4- channel remote control (integrated radio receiver) ARLU®-app or internet (Bluetooth and WiFi interface)



rob  
**SYMMETRICAL  
SLIDING SHUTTERS**

Symmetrical shutters can be used when there is not enough space available on one side of the window. In a symmetrical system, two shutters are positioned either side of the window, which also has a beneficial effect on the appearance of the façade. Both shutters are connected through a belt to ensure they move simultaneously. With the right choice of bottom guiding system, shutter installations can be expanded from a maximum of 3 m<sup>2</sup> to a maximum of 6 m<sup>2</sup>. Shutters can be automated for even greater ease of use. What's more, this automation makes it possible to operate the shutters without any need to be able to open the window.

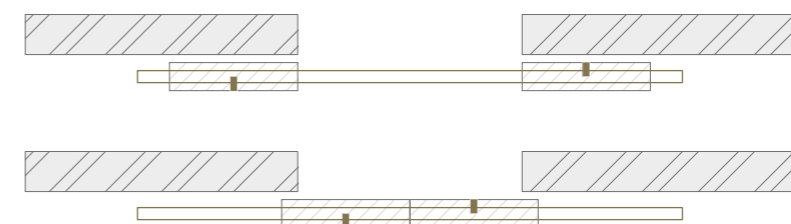

Technical drawing

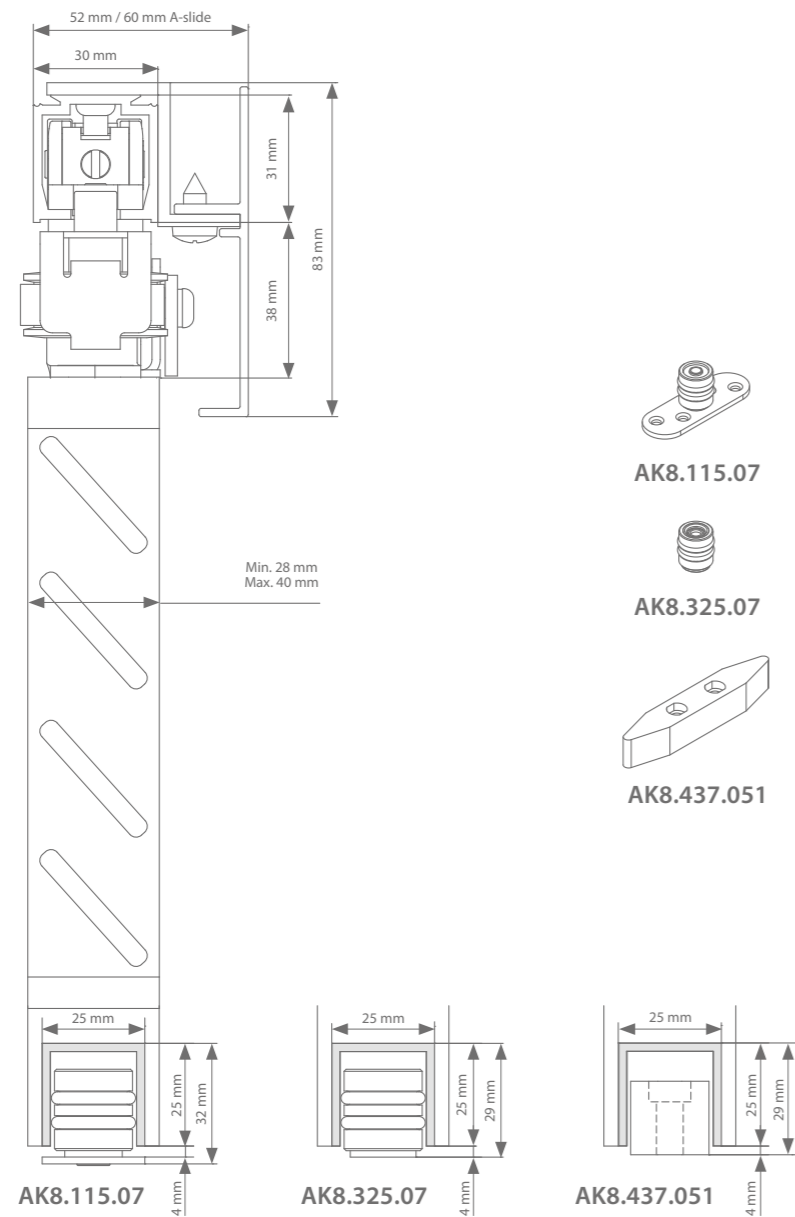

Product requirements

Shutter weight	Max. 80 kg per panel
Automated shutter weight	Max. 40 kg per panel
Wind permeability	Min. 50 %
Surface area	Max. 6m <sup>2</sup> with an additional guiding system
Min. clearance	950 mm - max. clearance = 2900 mm
Height adjustment	+ / - 3 mm

Profiles

	Max. shutter width	Length	Article number
<b>Running track</b> (grey anodised aluminium)	500 mm	2000 mm	AK0.208.200
	750 mm	3000 mm	AK0.208.300
	1000 mm	4000 mm	AK0.208.400
	1500 mm	6000 mm	AK0.208.600
<b>Cover profile</b> (untreated aluminium)	500 mm	2000 mm	AG9.938.200
	750 mm	3000 mm	AG9.938.300
	1000 mm	4000 mm	AG9.938.400
	1500 mm	6000 mm	AG9.938.600
<b>+ mounting bracket for cover profile</b>	Required every 480 mm		AG1.138.1 AG1.137.2 (with A-slide)
<b>+ set of screws</b>	Required every 3000 mm		AG1.128.300.9

Floor-mounted guiding system

<b>Guiding track 2x</b> (untreated aluminium)	1000 mm	1000 mm	AK0.618.100
	2000 mm	2000 mm	AK0.618.200
	3000 mm	3000 mm	AK0.618.300
	4000 mm	4000 mm	AK0.618.400
	6000 mm	6000 mm	AK0.618.600
<b>Guiding system options</b>	2x required up to shutter surface area of 3 m <sup>2</sup>		AK8.115.07
			AK8.325.07
	3x required up to shutter surface area of 6 m <sup>2</sup>		AK8.437.051

Manual gear

Suspension	Transverse suspension	Article number
Fittings (min. shutter width = 460 mm)	Set with 4 rollers, 2 stoppers, 4 support plates, 2 carriers and 2 reversing wheels	AK0.700.004
	Min. belt length in metres = (8 x shutter width) + 200 mm	(no. of metres) x AK9.709.001

A-slide gear

Suspension	Transverse suspension with motor	Article number
Fittings (min. shutter width = 460 mm, motor above shutter = 680 mm)	Superior set with 4 rollers, 2 stoppers, 4 support plates, 2 carriers, reversing wheel and motor	AK3.700.004
	Min. belt length in metres = (8 x shutter width) + 200 mm	(aantal meter) x AK9.709.001
Remote control	for 1 channel	AM3.100.104.61
	for 4 channels	AM3.100.104.64

## Technical drawing

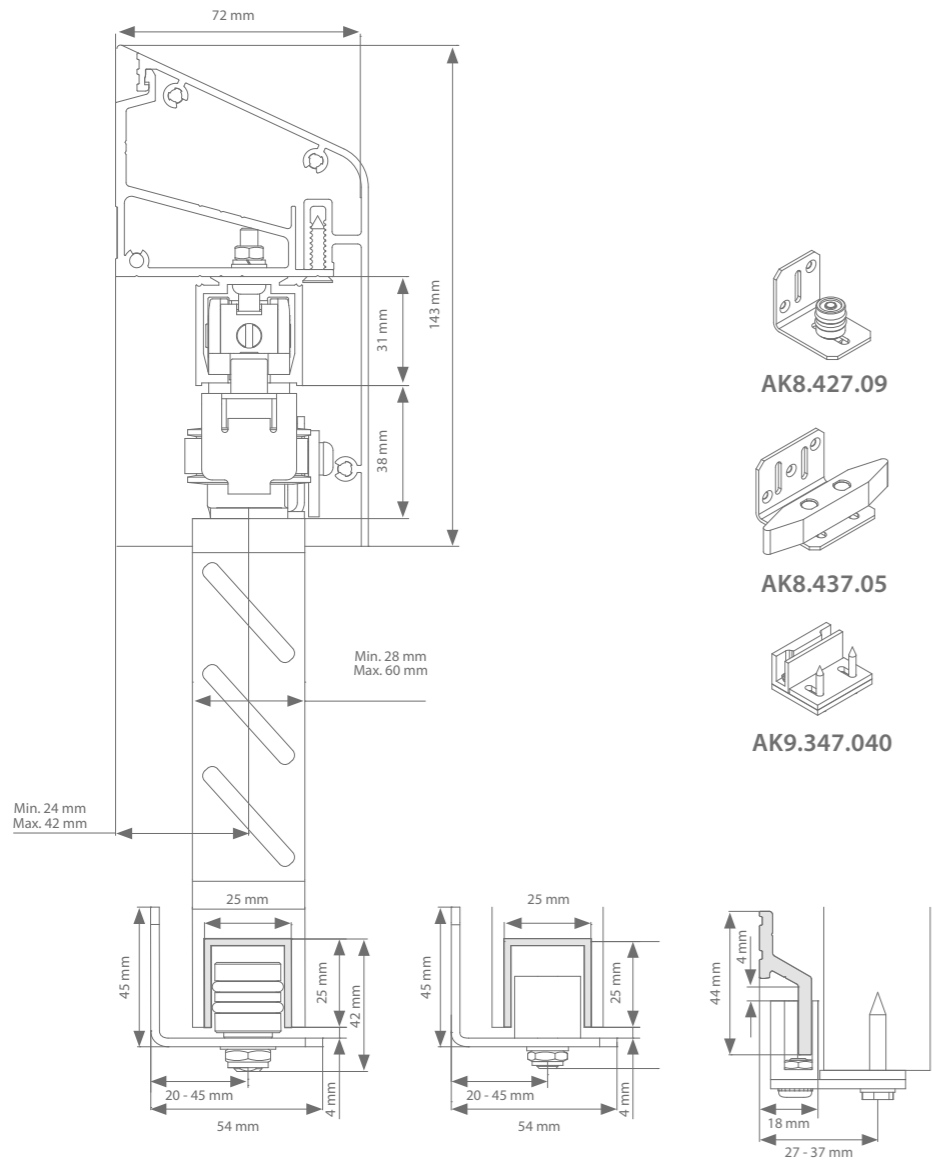

Option 1 - AK8.427.09

Option 1 - AK8.437.05

Option 2 - AK9.347.040

## Product requirements

Shutter weight	Max. 80 kg per panel
Automated shutter weight	Max. 40 kg per panel
Wind permeability	Min. 50 %
Surface area	Max. 6m <sup>2</sup> with an additional guiding system
Min. clearance	950 mm - max. clearance = 2900 mm
Height adjustment	+ / - 3 mm

## Advantages

The main advantage of a support profile is that it facilitates quicker installation compared to measuring and positioning every wall bracket.

## Profiles

	Max. shutter width	Length	Article number
<b>Running profile</b> (grey anodised aluminium)	500 mm	2000 mm	AK0.208.200
	750 mm	3000 mm	AK0.208.300
	1000 mm	4000 mm	AK0.208.400
	1500 mm	6000 mm	AK0.208.600
<b>Support profile</b> (untreated aluminium)	500 mm	2000 mm	AK1.128.200
	750 mm	3000 mm	AK1.128.300
	1000 mm	4000 mm	AK1.128.400
	1500 mm	6000 mm	AK1.128.600
<b>Cover profile</b> (untreated aluminium)	500 mm	2000 mm	AK9.928.200
	750 mm	3000 mm	AK9.928.300
	1000 mm	4000 mm	AK9.928.400
	1500 mm	6000 mm	AK9.928.600
<b>+ mounting bracket for cover profile</b>	Required every 480 mm		AK9.928
<b>+ set of screws</b>	Required every 3000 mm		AK1.128.300.9

## Wall-mounted guiding system option 1

<b>Guiding track 2x</b> (untreated aluminium)	1000 mm	1000 mm	AK0.618.100
	2000 mm	2000 mm	AK0.618.200
	3000 mm	3000 mm	AK0.618.300
	4000 mm	4000 mm	AK0.618.400
	6000 mm	6000 mm	AK0.618.600
<b>Guiding system options</b>	2x required up to shutter surface area of 3 m <sup>2</sup>		AK8.427.09
	3x required up to shutter surface area of 6 m <sup>2</sup>		AK8.437.05

## Wall-mounted guiding system option 2

<b>Guiding track</b> (untreated aluminium)	500 mm	2000 mm	AK9.340.200
	750 mm	3000 mm	AK9.340.300
	1000 mm	4000 mm	AK9.340.400
	1500 mm	6000 mm	AK9.340.600
<b>Guiding system options</b>	4x required up to shutter surface area of 3 m <sup>2</sup> / 8x required up to shutter surface area of 6 m <sup>2</sup>		AK9.347.040

## Manual gear

Suspension	Transverse suspension	Article number
Fittings (min. shutter width = 460 mm)	Set with 4 rollers, 2 stoppers, 4 support plates, 2 carriers and 2 reversing wheels	AK0.700.004
	Min. belt length in metres = (8 x shutter width) + 200 mm	(no. of metres) x AK9.709.001

## A-slide gear

Suspension	Transverse suspension with motor	Article number
Fittings (min. shutter width = 460 mm, motor above shutter = 680 mm)	Superior set with 4 rollers, 2 stoppers, 4 support plates, 2 carriers, reversing wheel and motor	AK3.700.004
	Min. belt length in metres = (8 x shutter width) + 200 mm	(aantal meter) x AK9.709.001
Remote control	for 1 channel	AM3.100.104.61
	for 4 channels	AM3.100.104.64



---

rob  
**TELESCOPIC  
SLIDING SHUTTERS**

Windows are increasing in surface, but shutters often remain the preferred sun protection option. Using a telescopic system makes it possible to split wide shutters into 2 or 3 shutters, each of which can be stored compactly by the side of a large window. All shutters move simultaneously thanks to a belt connection, which also ensures silent operation. With the right choice of bottom guiding system, shutter installations can be expanded from a maximum of 3 m<sup>2</sup> to a maximum of 6 m<sup>2</sup>. Shutters can be automated for even greater ease of use. What's more, this automation makes it possible to operate the shutters without any need to be able to open the window.

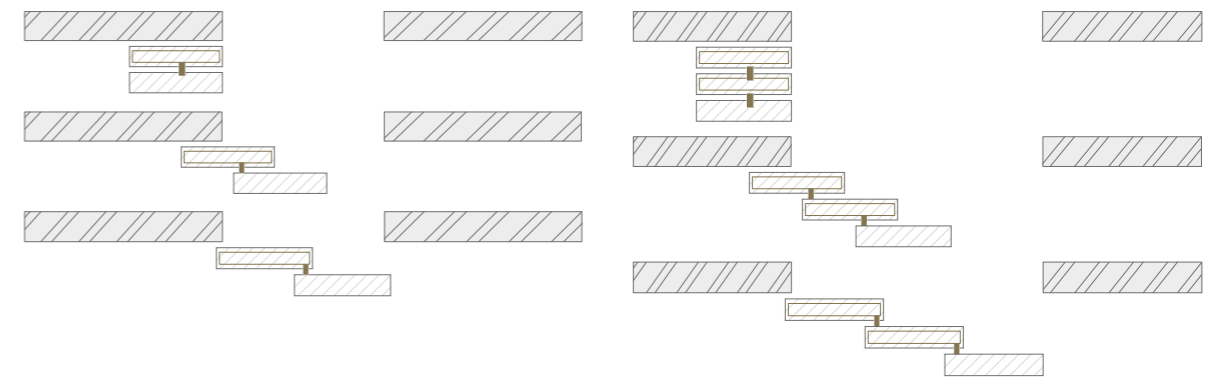

Technical drawing

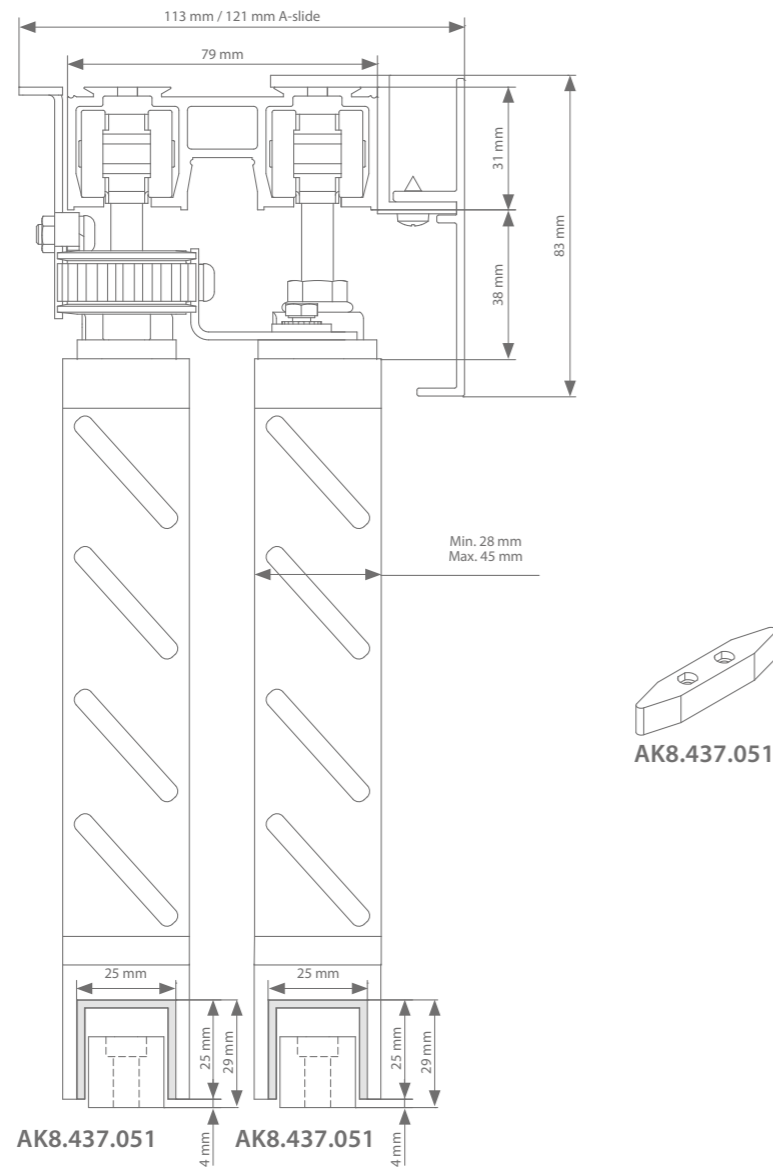

Product requirements

Shutter weight	Max. 80 kg per panel
Automated shutter weight	Max. 40 kg per panel
Wind permeability	Min. 50 %
Surface area	Max. 6m <sup>2</sup> with an additional guiding system
Min. clearance	1120 mm - max. clearance = 3900 mm
Height adjustment	+ / - 3 mm

Profiles

	Max. shutter width	Length	Article number
Running track (grey anodised aluminium)	667 mm	2000 mm	AK0.202.200
	1000 mm	3000 mm	AK0.202.300
	1333 mm	4000 mm	AK0.202.400
	2000 mm	6000 mm	AK0.202.600
Cover profile (untreated aluminium)	667 mm	2000 mm	AG9.938.200
	1000 mm	3000 mm	AG9.938.300
	1333 mm	4000 mm	AG9.938.400
	2000 mm	6000 mm	AG9.938.600
+ mounting bracket for cover profile	Required every 480 mm		AG1.138.1 AG1.137.2 (with A-slide)
+ set of screws	Required every 3000 mm		AG1.128.300.9

Floor-mounted guiding system

Guiding track 2x (untreated aluminium)	1000 mm	1000 mm	AK0.618.100
	2000 mm	2000 mm	AK0.618.200
	3000 mm	3000 mm	AK0.618.300
	4000 mm	4000 mm	AK0.618.400
	6000 mm	6000 mm	AK0.618.600
Guiding system options	3x required up to shutter surface area of 3m <sup>2</sup> / 7x required up to shutter surface area of 6 m <sup>2</sup>		AK8.437.051

Manual gear

Suspension	Transverse suspension	Article number
Fittings (min. shutter width = 400 mm)	Set with 4 rollers, 2 stoppers, 4 support plates, 1 carrier, 1 lock system and 2 reversing wheels	AK0.800.004
	Min. belt length in metres = (2 x shutter width) + 400 mm	(no. of metres) x AK9.709.001

A-slide gear

Suspension	Transverse suspension with motor	Article number
Fittings (min. shutter width = 500 mm, motor above shutter = 720 mm)	Superior set with 4 rollers, 2 stoppers, 4 support plates, 2 carriers, 1 lock system, 3 reversing wheels and motor	AK3.800.004
	Min. belt length in metres = (8 x shutter width) + 600 mm	(aantal meter) x AK9.709.001
Remote control	for 1 channel	AM3.100.104.61
	for 4 channels	AM3.100.104.64

### Technical drawing

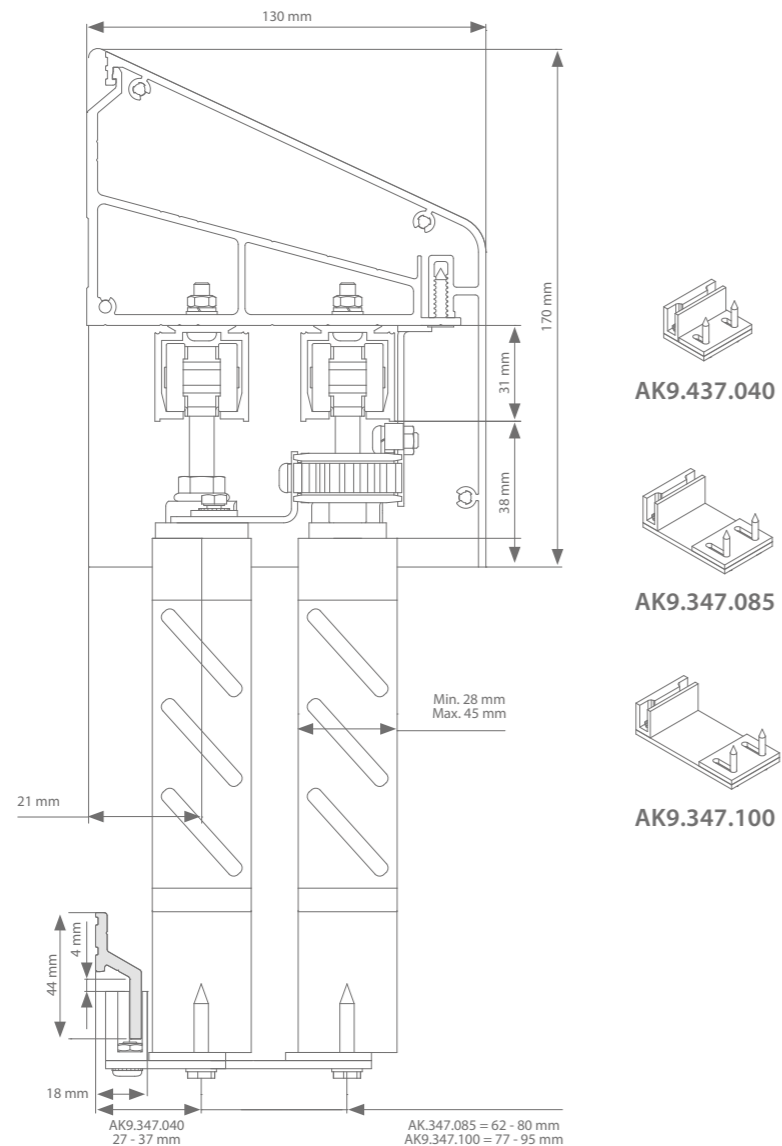

### Product requirements

Shutter weight	Max. 80 kg per panel
Automated shutter weight	Max. 40 kg per panel
Wind permeability	Min. 50 %
Surface area	Max. 6m <sup>2</sup> with an additional guiding system
Min. clearance	1120 mm - max. clearance = 3900 mm
Height adjustment	+ / - 3 mm

### Profiles

	Max. shutter width	Length	Article number
Running track (2x) (grey anodised aluminium)	667 mm	2000 mm	AK0.208.200
	1000 mm	3000 mm	AK0.208.300
	1333 mm	4000 mm	AK0.208.400
	2000 mm	6000 mm	AK0.208.600
Support profile (untreated aluminium)	667 mm	2000 mm	AK1.168.200
	1000 mm	3000 mm	AK1.168.300
	1333 mm	4000 mm	AK1.168.400
	2000 mm	6000 mm	AK1.168.600
Cover profile (untreated aluminium)	667 mm	2000 mm	AK9.968.200
	1000 mm	3000 mm	AK9.968.300
	1333 mm	4000 mm	AK9.968.400
	2000 mm	6000 mm	AK9.968.600
+ set of end caps		1x required	AK9.968
+ set of screws		Required every 3000 mm	AK1.168.300.9

### Floor-mounted guiding system

	Max. shutter width	Length	Article number
Guiding track (untreated aluminium)	667 mm	2000 mm	AK9.340.200
	1000 mm	3000 mm	AK9.340.300
	1333 mm	4000 mm	AK9.340.400
Guiding system options		2x required up to shutter surface area of 3 m <sup>2</sup> / 4x required up to shutter surface area of 6 m <sup>2</sup>	AK9.347.040
		2x required up to shutter surface area of 3 m <sup>2</sup> / 4x required up to shutter surface area of 6 m <sup>2</sup>	AK9.347.085 (shutter thickness 28 - 35)
		2x required up to shutter surface area of 3 m <sup>2</sup> / 4x required up to shutter surface area of 6 m <sup>2</sup>	AK9.347.100 (shutter thickness 36 - 45)

### Manual gear

Suspension	Transverse suspension	Article number
Fittings (min. shutter width = 400 mm)	Set with 4 rollers, 2 stoppers, 4 support plates, 1 carrier, 1 lock system and 2 reversing wheels	AK0.800.004
	Min. belt length in metres = (2 x shutter width) + 400 mm	(no. of metres) x AK9.709.001

### A-slide gear

Suspension	Transverse suspension with motor	Article number
Fittings (min. shutter width = 500 mm, motor above shutter = 720 mm)	Superior set with 4 rollers, 2 stoppers, 4 support plates, 2 carriers, 1 lock system, 3 reversing wheels and motor	AK3.800.004
	Min. belt length in metres = (8 x shutter width) + 600 mm	(aantal meter) x AK9.709.001
Remote control	for 1 channel	AM3.100.104.61
	for 4 channels	AM3.100.104.64

Technical drawing

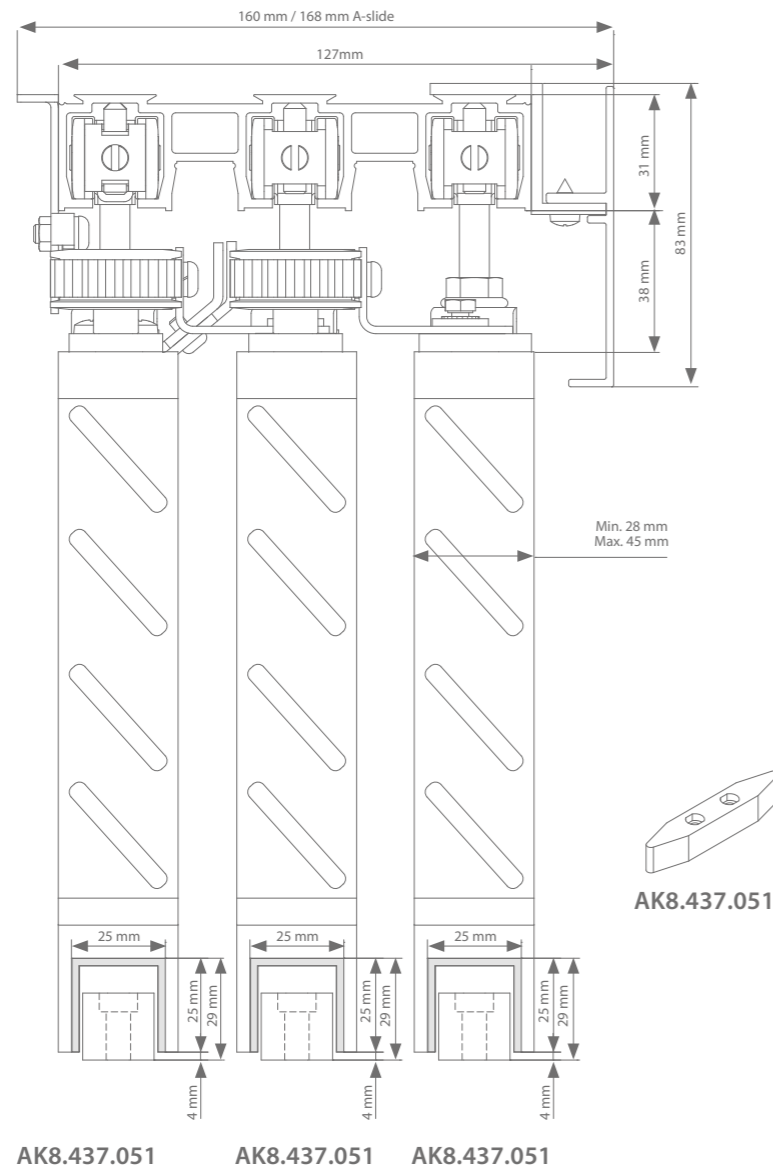

Product requirements

Shutter weight	Max. 80 kg per panel
Wind permeability	Min. 50 %
Surface area	Max. 6m <sup>2</sup> with an additional guiding system
Min. clearance	1680 mm - max. clearance = 4400 mm
Height adjustment	+ / - 3 mm

Profiles

	Max. shutter width	Length	Article number
Running track (grey anodised aluminium)	500 mm	2000 mm	AK0.203.200
	750 mm	3000 mm	AK0.203.300
	1000 mm	4000 mm	AK0.203.400
	1500 mm	6000 mm	AK0.203.600
Cover profile (untreated aluminium)	500 mm	2000 mm	AG9.938.200
	750 mm	3000 mm	AG9.938.300
	1000 mm	4000 mm	AG9.938.400
	1500 mm	6000 mm	AG9.938.600
+ mounting bracket for cover profile	Required every 480 mm		AG1.138.1 AG1.137.2 (with A-slide)
+ set of screws	Required every 3000 mm		AG1.128.300.9

Floor-mounted guiding system

Guiding track 3x (untreated aluminium)	1000 mm	1000 mm	AK0.618.100
	2000 mm	2000 mm	AK0.618.200
	3000 mm	3000 mm	AK0.618.300
	4000 mm	4000 mm	AK0.618.400
	6000 mm	6000 mm	AK0.618.600
Guiding system options	6x required up to shutter surface area of 3 m <sup>2</sup> 12x required up to shutter surface area of 6 m <sup>2</sup>		AK8.437.051

Manual gear

Suspension	Transverse suspension	Article number
Fittings (min. shutter width = 400 mm)	Set with 6 rollers, 2 stoppers, 6 support plates, 2 carriers, 1 lock system and 4 reversing wheels Min. belt length in metres = (4 x shutter width) + 400 mm	AK0.803.004 (no. of metres) x AK9.709.001

A-slide gear

Suspension	Transverse suspension with motor	Article number
Fittings (min. shutter width = 500 mm, motor above shutter = 720 mm)	Superior set with 6 rollers, 2 stoppers, 6 support plates, 3 carriers, 1 lock system, 5 reversing wheels and motor Min. belt length in metres = (12 x shutter width) + 600 mm	AK3.803.004 (aantal meter) x AK9.709.001
Remote control	for 1 channel	AM3.100.104.61
	for 4 channels	AM3.100.104.64



# 02

## FOLDING SHUTTER HARDWARE

Rob® folding shutters ensure that the shutter always hangs in front of the upper and lowermost profile, meaning the hardware is as good as completely concealed on the outer side of the building. As such, the design of the shutter is the only feature defining the look of the building. This type of suspension allows the shutters to extend above or below the profiles, meaning they link up seamlessly with any shutters above or below them. This makes it possible to perfectly integrate the folding shutters into the façade cladding.

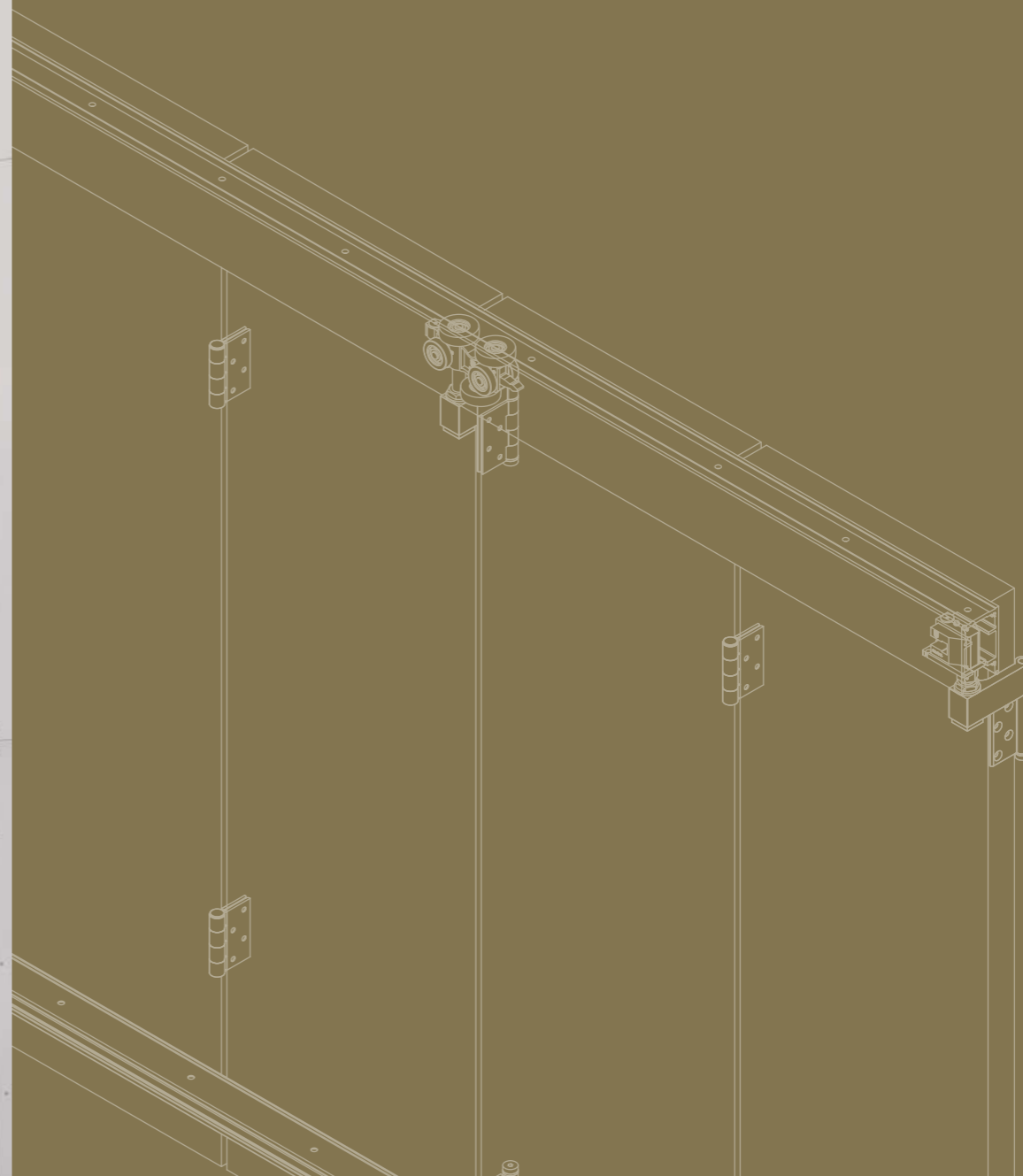

folding shutter hardware  
**general information**

Aluminium, timber and PVC

Folding shutter hardware can be used to equip folding shutters of 20 kg or up to 40 kg per shutter in wood, aluminium or PVC. Our hardware allows folding shutters to be mounted to either the façade or underneath the lintel, for an even number of panels. The hinges are placed on the side of the panels, and a locking option is available. When open, the shutters are at a right angle to the façade (90°). Our hardware guarantees extremely small installation dimensions. Through the special concept of front shutters with a connection against the profiles and a limited opening between the shutters, maximum sun protection is provided in a closed position. The concept of front shutters also offers the option of allowing the same shutter system to run across multiple floors.

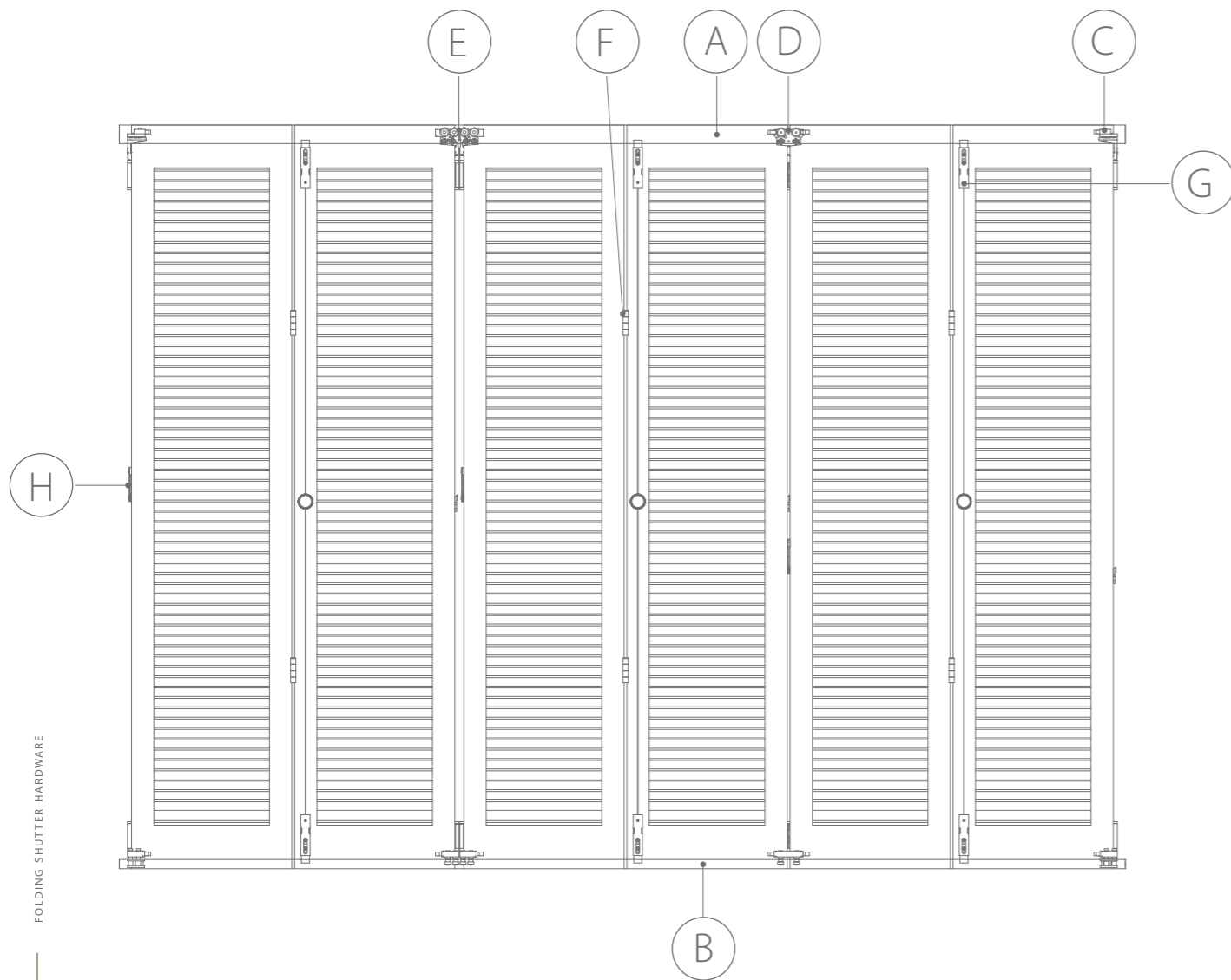

- A** The upper running track carries the weight of the panels. All running tracks in all weight categories can carry a maximum of 4 shutters on each side in a folded position. In case of lower weights per shutter, the number of shutters on each side can be increased as long as the total sum of the shutters does not exceed 4 times the maximum shutter weight. ( 4 x 20 kg or 4 x 40kg )

---

- B** The bottom guide track acts as a guiding system for the shutter. In our 20 kg hardware range in particular, we offer multiple track types for floor mounting, wall mounting and recessed installation, as well as a surface mounted track suitable for wheelchair users. If the situation permits, we recommend installing the guiding track with the opening downward. This setup will ensure no water or dirt remains inside the track, meaning it requires no maintenance and will continue to work well.

---

- C** The fixed pivot determines the direction the shutters fold in and the position they are stored in. Perfect perpendicular installation of the top and bottom pivot will ensure the system works well. The bottom pivot is vertically flexible. This unique concept allows the shutters to compensate for expansion or contraction of up to 6 mm without a problem. These folding shutters are the only ones on the market that will not be damaged by this kind of expansion.

---

- D** The middle roller holds the middle shutters in place and lines in with the fixed pivot in a folded position. This ensures the shutters are perfectly parallel to each other.

---

- E** The end roller also lines in with the middle roller to bring the final folded panels into a parallel position.

---

- F** Every shutter pair is connected to the others with hinges. The number of hinges is determined by the height of the shutter.

---

- G** Both locking systems are absolutely essential to withstand hurricane conditions of 12 Beaufort in a flat position.

---

- H** When the shutters are folded, they need a locking system to be able to withstand wind forces of up to 12 Beaufort. This locking system can be neatly concealed in the slots between the various panels.



rob  
**FOLDING SHUTTERS**  
20 KG

Folding shutters are the most compact method to stack a number of shutters aside a window. The gear positions of the shutter are always in front of the top and bottom track, turning the fittings almost invisible on the outside of the building. A folding shutter setup can be fully integrated in a facade cladding. The wide variety of tracks and the 2 types of suspension provide a solution for every facade. Locking in open and/or closed position makes the system resistant to important wind loads.



## rob folding shutters 20 kg product requirements



Our 20 kg folding shutters are tested and certified according to the EN 13659 wind load standard. This test subjects the setup to wind forces of 12 Beaufort.

	Beaufort	Wind speed km/h	Wind pressure Pa
Storm	10	89 - 102	374 - 505
Violent storm	11	103 - 117	506 - 665
Hurricane	12	118 - 133	666 - 853

Shutter weight	Max. 20 kg per panel
Number of shutters per side	Max. 4
Wind permeability	0 %
Surface area	Max. 1,5 m <sup>2</sup>
Height	Max. 3 m
Width	Max. 0,5 m
Thickness	30 - 34 mm

In the test, 4 folding shutters on 1 side were used with a maximum width of 0.5 m and a height of 3 m, leading to a surface area of 1.5 m<sup>2</sup>. Each shutter weighed 20 kg, resulting in a total weight of 80 kg.

If more panels are required on each side, the weight per shutter will need to be lowered:

**Max. weight per shutter (kg) = 80 kg / no. of shutters**

Shutters taller than 3 m are possible subject to the use of an additional middle hinge and if the maximum surface area of 1.5 m<sup>2</sup> is respected. If wider shutters are required, the weight per shutter will need to be lowered. Please contact our sales team to discuss these different requirements.

This setup – which is the heaviest possible – was subjected to a static test in which the wind pressure was applied frontally to the shutters in a closed position. The test was carried out on both the outer and inner side of the hardware. The fully closed shutters were subjected to wind pressure of 12 Beaufort.

The folding shutters subsequently underwent a dynamic test in which they were placed in a flat and folded position to be subjected to the same wind pressure. The shutters were turned through 90° each time to simulate the heaviest wind load.

The folding shutters always need a locking system at the top and bottom to be able to withstand such heavy wind loads in a flat position. When the shutters are in a folded position, they need a middle locking system to be able to withstand hurricane conditions. The shutters are only resistant to these wind loads when they are locked in an open or closed position.



static test



dynamic test



dynamic test

\*Test reports can be requested during the sales process. \*\* Any warranty will lapse if the proposed setup and the components used therein are deviated from.

Technical drawings

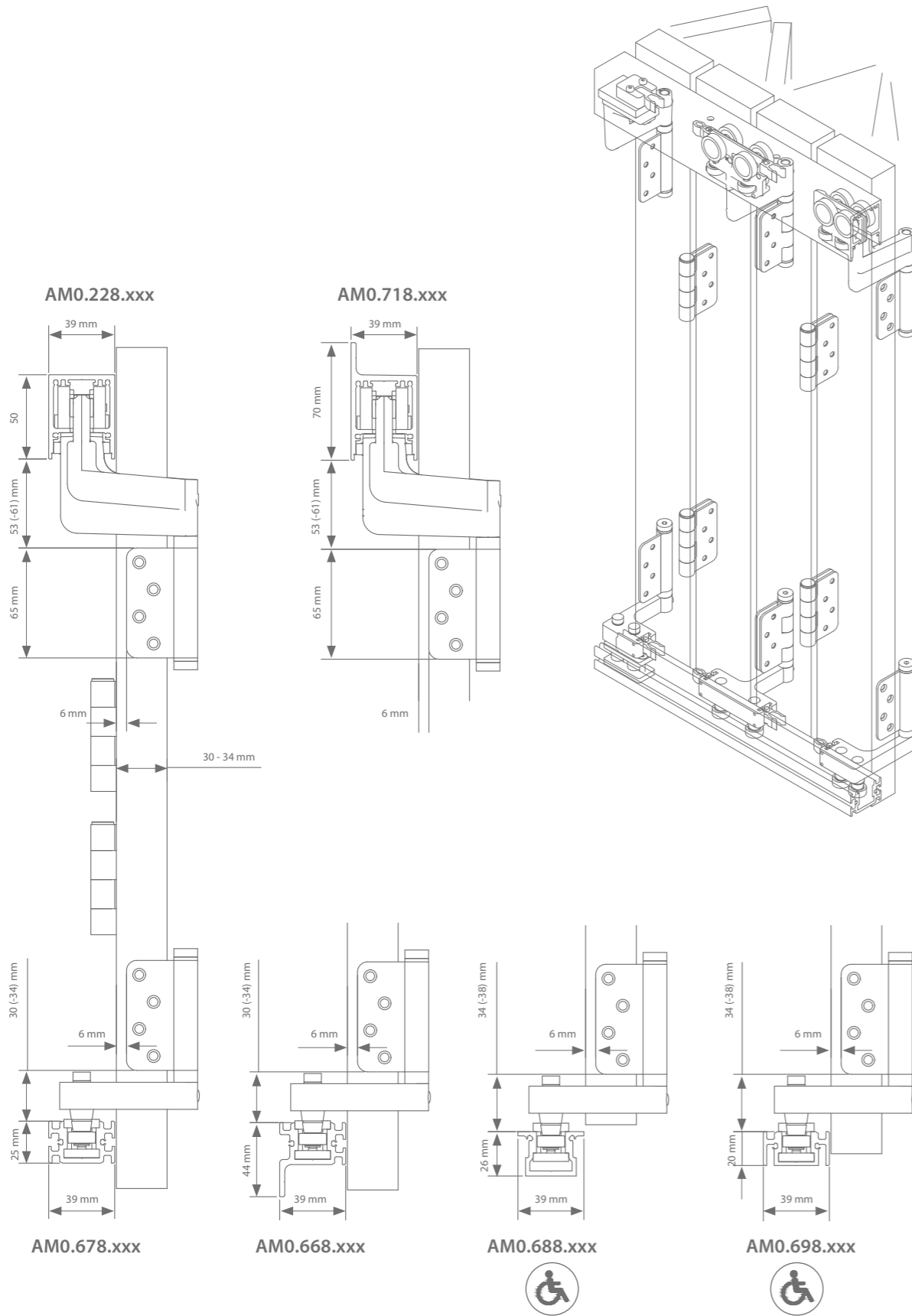

Accessories selection Shutter setup looking from the inside out

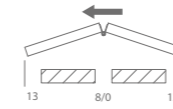

2 Shutters left	Product code
Interior standard	AM0.440.402.00
Interior + RAL of choice	on demand
Coastal area* standard	AM0.445.402.00
Coastal area* + RAL of choice	on demand

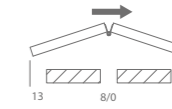

2 Shutters right	Product code
Interior standard	AM0.440.400.02
Interior + RAL of choice	on demand
Coastal area* standard	AM0.445.400.02
Coastal area* + RAL of choice	on demand

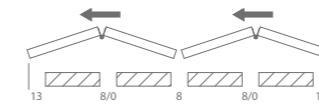

4 Shutters left	Product code
Interior standard	AM0.440.404.00
Interior + RAL of choice	on demand
Coastal area* standard	AM0.445.404.00
Coastal area* + RAL of choice	on demand

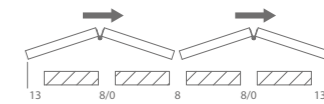

4 Shutters right	Product code
Interior standard	AM0.440.400.04
Interior + RAL of choice	on demand
Coastal area* standard	AM0.445.400.04
Coastal area* + RAL of choice	on demand

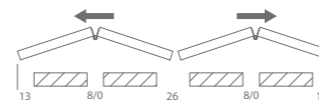

2 Shutters left - 2 Shutters right	Product code
Interior standard	AM0.440.402.02
Interior + RAL of choice	on demand
Coastal area* standard	AM0.445.402.02
Coastal area* + RAL of choice	on demand

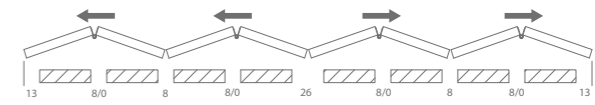

4 Shutters left - 4 Shutters right	Product code
Interior standard	AM0.440.404.04
Interior + RAL of choice	on demand
Coastal area* standard	AM0.445.404.04
Coastal area* + RAL of choice	on demand

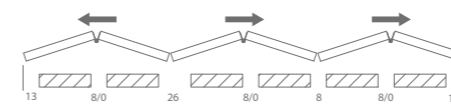

2 Shutters left - 4 Shutters right	Product code
Interior standard	AM0.440.402.04
Interior + RAL of choice	on demand
Coastal area* standard	AM0.445.402.04
Coastal area* + RAL of choice	on demand

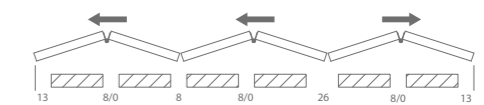

4 Shutters left - 2 Shutters right	Product code
Interior standard	AM0.440.404.02
Interior + RAL of choice	on demand
Coastal area* standard	AM0.445.404.02
Coastal area* + RAL of choice	on demand

\* The coastal area version is necessary when the folding shutters are installed within 20 km of a coastline. The coastal version is also required in areas with high pollution, high salinity, or high contamination.

Technical drawings

Accessories selection Shutter setup looking from the inside out

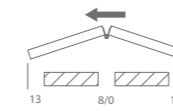
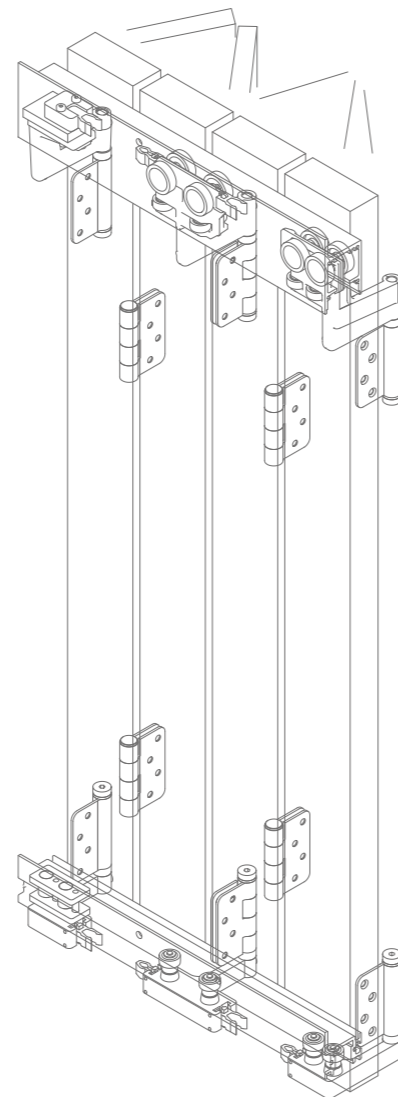
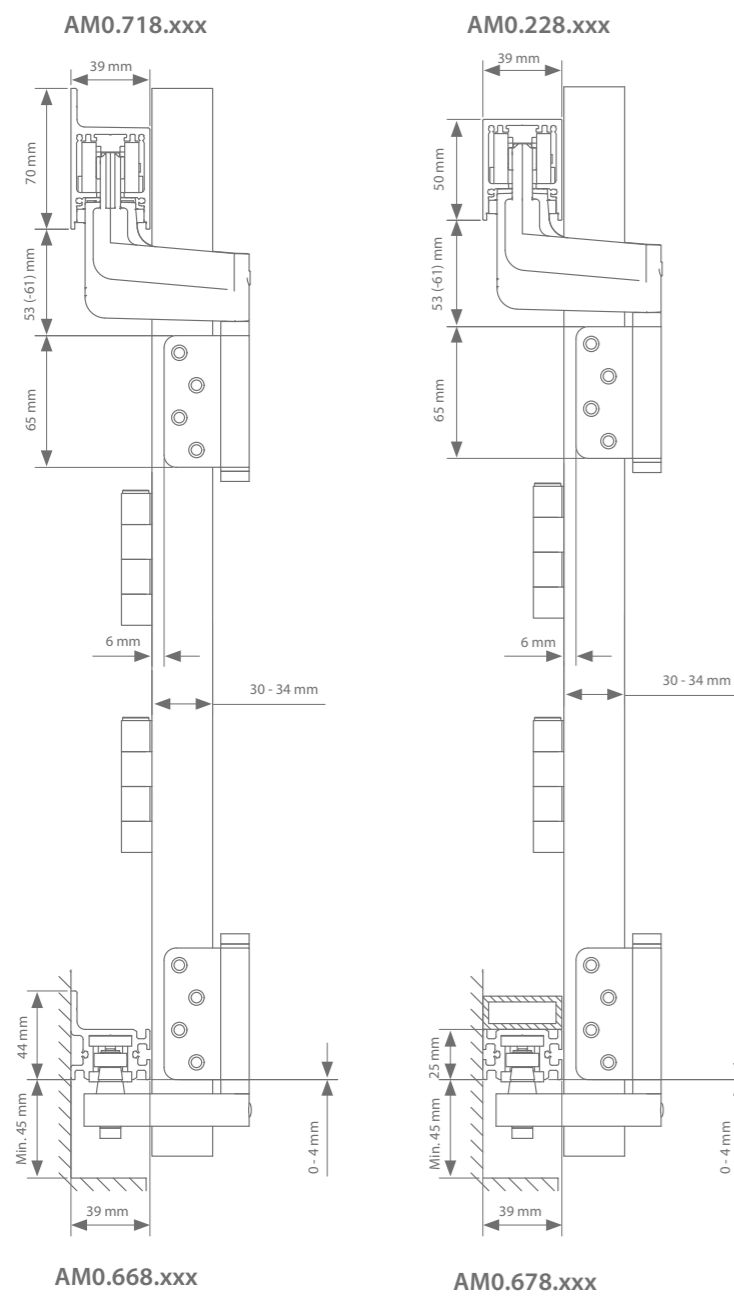

2 Shutters left	Article number
Interior standard	AM0.440.602.00
Interior + RAL of choice	on demand
Coastal area* standard	AM0.445.602.00
Coastal area* + RAL of choice	on demand

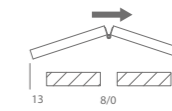

2 Shutters right	Article number
Interior standard	AM0.440.600.02
Interior + RAL of choice	on demand
Coastal area* standard	AM0.445.600.02
Coastal area* + RAL of choice	on demand

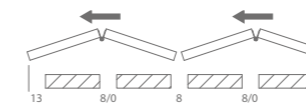

4 Shutters left	Article number
Interior standard	AM0.440.604.00
Interior + RAL of choice	on demand
Coastal area* standard	AM0.445.604.00
Coastal area* + RAL of choice	on demand

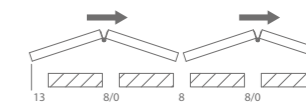

4 Shutters right	Article number
Interior standard	AM0.440.600.04
Interior + RAL of choice	on demand
Coastal area* standard	AM0.445.600.04
Coastal area* + RAL of choice	on demand

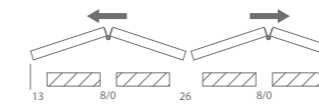

2 Shutters left - 2 Shutters right	Article number
Interior standard	AM0.440.602.02
Interior + RAL of choice	on demand
Coastal area* standard	AM0.445.602.02
Coastal area* + RAL of choice	on demand

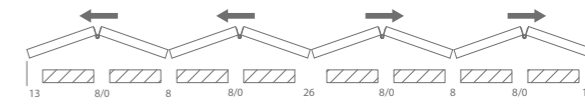

4 Shutters left - 4 Shutters right	Article number
Interior standard	AM0.440.604.04
Interior + RAL of choice	on demand
Coastal area* standard	AM0.445.604.04
Coastal area* + RAL of choice	on demand

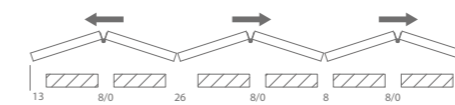

2 Shutters left - 4 Shutters right	Article number
Interior standard	AM0.440.602.04
Interior + RAL of choice	on demand
Coastal area* standard	AM0.445.602.04
Coastal area* + RAL of choice	on demand

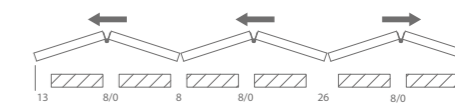

4 Shutters left - 2 Shutters right	Article number
Interior standard	AM0.440.604.02
Interior + RAL of choice	on demand
Coastal area* standard	AM0.445.604.02
Coastal area* + RAL of choice	on demand

\* The coastal area version is necessary when the folding shutters are installed within 20 km of a coastline. The coastal version is also required in areas with high pollution, high salinity, or high contamination.



Middle hinges

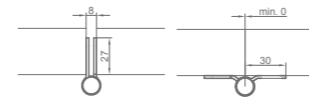

	Shutter height	No. of hinges per 2 shutters	Intermediate hinge	Rear hinge *clearance can be reduced to 0 mm
Middle hinge (stainless steel)	H < 1500 mm	2	AM5.427	AM5.427
	1500 mm < H < 2400 mm	3		
	2400 mm < H < 3000 mm	4		
Middle hinge RAL of choice	H < 1500 mm	2	on demand	on demand
	1500 mm < H < 2400 mm	3		
	2400 mm < H < 3000 mm	4		

Profiles

	Length	Untreated aluminium	Anodised alu	+ RAL of choice
Top track Lintel mounting	2000 mm	AM0.228.200	AM0.228.200.0	on demand
	3000 mm	AM0.228.300	AM0.228.300.0	
	4000 mm	AM0.228.400	AM0.228.400.0	
	6000 mm	AM0.228.600	AM0.228.600.0	
Top track Wall mounting	2000 mm	AM0.718.200	AM0.718.200.0	on demand
	3000 mm	AM0.718.300	AM0.718.300.0	
	4000 mm	AM0.718.400	AM0.718.400.0	
	6000 mm	AM0.718.600	AM0.718.600.0	
Bottom track Floor mounting	2000 mm	AM0.678.200	AM0.678.200.0	on demand
	3000 mm	AM0.678.300	AM0.678.300.0	
	4000 mm	AM0.678.400	AM0.678.400.0	
	6000 mm	AM0.678.600	AM0.678.600.0	
Bottom track Wall mounting	2000 mm	AM0.668.200	AM0.668.200.0	on demand
	3000 mm	AM0.668.300	AM0.668.300.0	
	4000 mm	AM0.668.400	AM0.668.400.0	
	6000 mm	AM0.668.600	AM0.668.600.0	
Bottom track Terrace profile for recessed installation	2000 mm	AM0.688.200	AM0.688.200.0	on demand
	3000 mm	AM0.688.300	AM0.688.300.0	
	4000 mm	AM0.688.400	AM0.688.400.0	
	6000 mm	AM0.688.600	AM0.688.600.0	
Bottom track Floor mounting suitable for wheelchairs	2000 mm	AM0.698.200	AM0.698.200.0	on demand
	3000 mm	AM0.698.300	AM0.698.300.0	
	4000 mm	AM0.698.400	AM0.698.400.0	
	6000 mm	AM0.698.600	AM0.698.600.0	



Associated locking system

All locking systems listed are required to ensure that the shutters can handle the wind load in a flat or folded position.

Shutter setup looking from the inside out	Number of locking systems required for flat position		Number of locking systems required for folded position	
	AM9.728 or AM9.725 or AM9.748.240	AM9.728.02*	AM9.738* or AM9.737*	
2R	1x	1x	1x	
2L	1x	1x	1x	
2R	2x	2x	2x	
4R	2x	2x	2x	
4L	2x	2x	2x	
4R	4x	4x	4x	
2R	3x	3x	3x	
4R	3x	3x	3x	

If using profile AM0.688.xxx, you will need an AM9.727.03 terrace piece per locking system in a flat position.  
\* Locking mechanism AM9.728.02, AM9.738 or AM9.737 are only required if the area of the shutter exceeds 1,1m<sup>2</sup>.

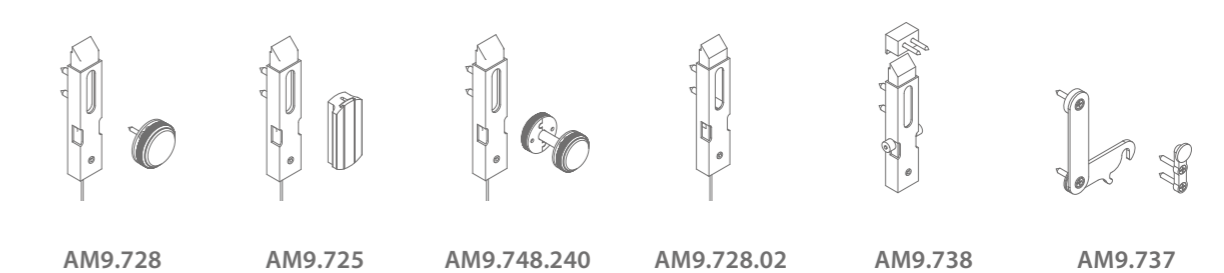
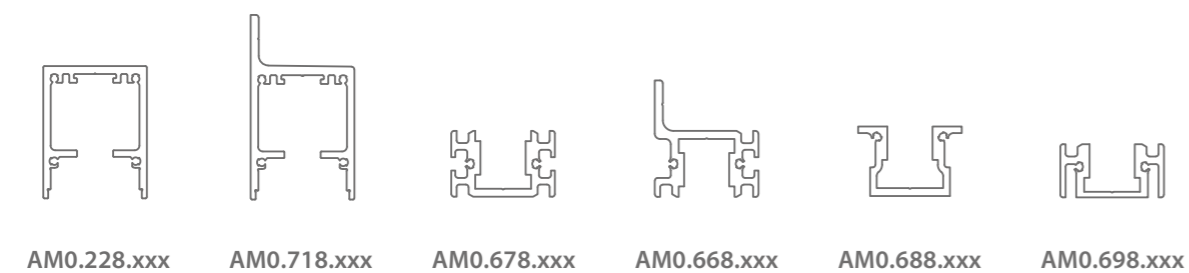



rob  
**FOLDING SHUTTERS**  
40 KG

Folding shutters are the most compact method to stack a number of shutters aside a window. The gear positions the shutter always in front of the top and bottom track turning the fittings almost invisible on the outside of the building. A folding shutter setup can be fully integrated in a facade cladding. The folding shutters up to 40 kg per panel are the strongest of its kind and are able to fold full panels up to 2.4 m<sup>2</sup>. Locking in open and/or closed position makes the system resistant to important wind loads.



## rob folding shutters 40 kg product requirements



Our 40 kg folding shutters are tested and certified according to the EN 13659 wind load standard. This test subjects the setup to wind forces of 12 Beaufort.

	Beaufort	Wind speed km/h	Wind pressure Pa
Storm	10	89 - 102	374 - 505
Violent storm	11	103 - 117	506 - 665
Hurricane	12	118 - 133	666 - 853

Shutter weight	Max. 40 kg per panel
Number of shutters per side <sup>1</sup>	Max. 4
Wind permeability	0 %
Surface area	Max. 2,4 m <sup>2</sup>
Height <sup>2</sup>	Max. 3 m
Width <sup>3</sup>	Max. 0,8 m
Shutter thickness	30 - 34 mm / 40 mm

In the test, 4 folding shutters on 1 side were used with a maximum width of 0.8 m and a height of 3 m, leading to a surface area of 2.4 m<sup>2</sup>. Each shutter weighed 40 kg, resulting in a total weight of 160 kg.

If more panels are required on each side, the weight per shutter will need to be lowered:

**Max. weight per shutter (kg) = 160 kg / no. of shutters**

Shutters taller than 3 m are possible subject to the use of an additional middle hinge and if the maximum surface area of 2.4 m<sup>2</sup> is respected. If wider shutters are required, the weight per shutter will need to be lowered. Please contact our sales team to discuss these different requirements.

This setup – which is the heaviest possible – was subjected to a static test in which the wind pressure was applied frontally to the shutters in a closed position. The test was carried out on both the outer and inner side of the hardware. The fully closed shutters were subjected to wind pressure of 12 Beaufort.

The folding shutters subsequently underwent a dynamic test in which they were placed in a flat and folded position to be subjected to the same wind pressure. The shutters were turned through 90° each time to simulate the heaviest wind load.

The folding shutters always need a locking system at the top and bottom to be able to withstand such heavy wind loads in a flat position. When the shutters are in a folded position, they need a middle locking system to be able to withstand hurricane conditions. The shutters are only resistant to these wind loads when they are locked in an open or closed position.

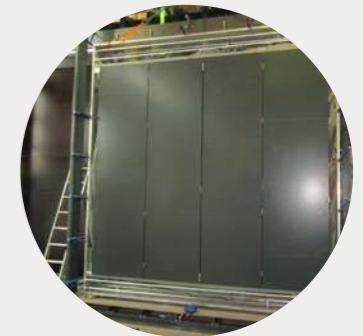

static test



dynamic test



dynamic test

<sup>1</sup>Test reports can be requested during the sales process. <sup>2</sup>Any warranty will lapse if the proposed setup and the components used therein are deviated from.

Technical drawings

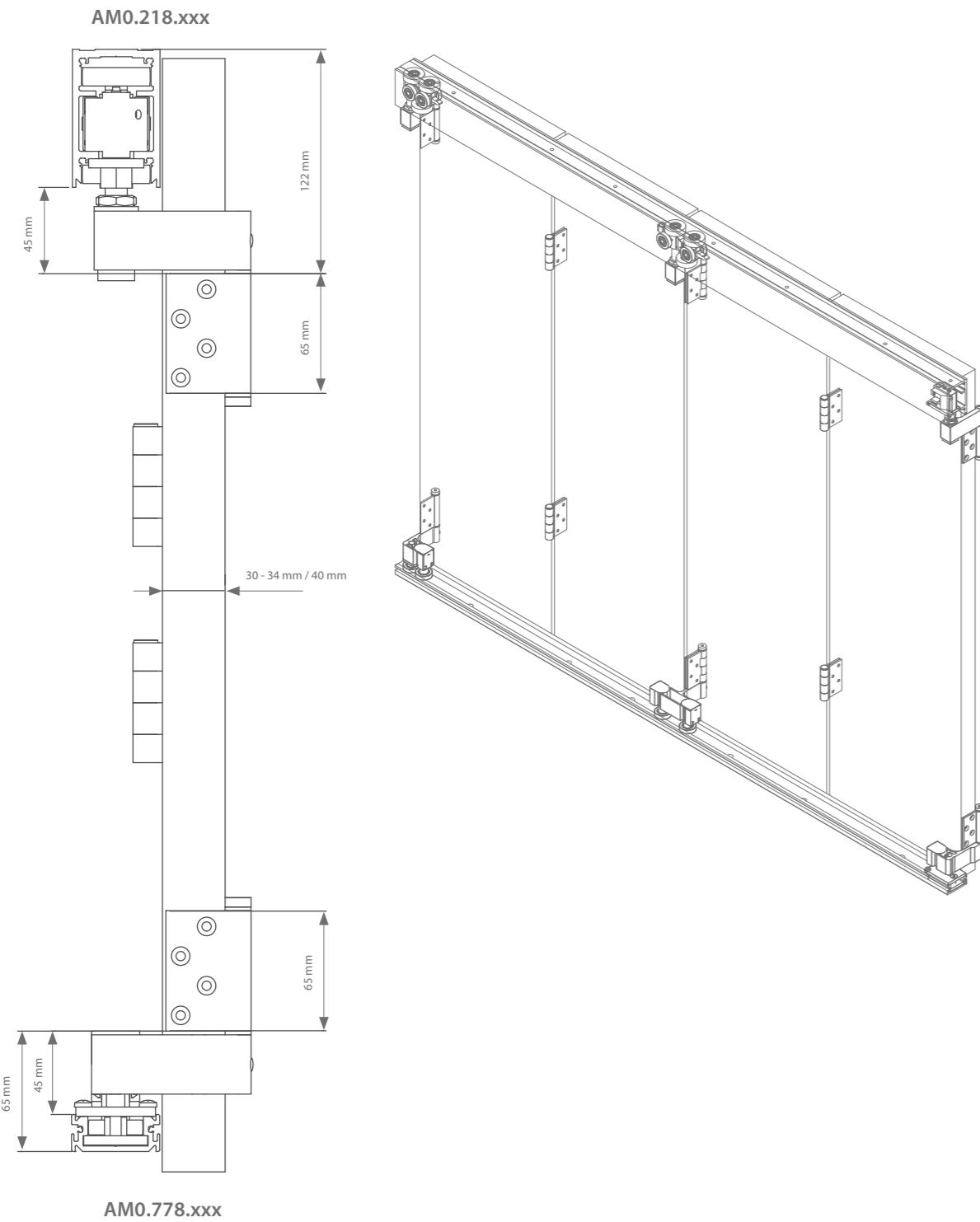

Accessories selection Shutter setup looking from the inside out

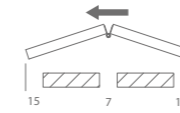

2 Shutters left	Shutter thickness 30-34 mm	Shutter thickness 40 mm
Anodised aluminium	AM0.455.402.00	AM0.465.402.00
+ RAL of choice	on demand	on demand

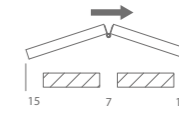

2 Shutters right	Shutter thickness 30-34 mm	Shutter thickness 40 mm
Anodised aluminium	AM0.455.400.02	AM0.465.400.02
+ RAL of choice	on demand	on demand

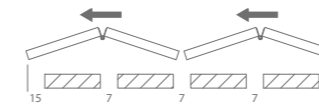

4 Shutters left	Shutter thickness 30-34 mm	Shutter thickness 40 mm
Anodised aluminium	AM0.455.404.00	AM0.465.404.00
+ RAL of choice	on demand	on demand

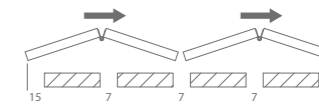

4 Shutters right	Shutter thickness 30-34 mm	Shutter thickness 40 mm
Anodised aluminium	AM0.455.400.04	AM0.465.400.04
+ RAL of choice	on demand	on demand

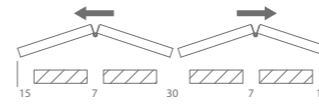

2 Shutters left - 2 Shutters right	Shutter thickness 30-34 mm	Shutter thickness 40 mm
Anodised aluminium	AM0.455.402.02	AM0.465.402.02
+ RAL of choice	on demand	on demand

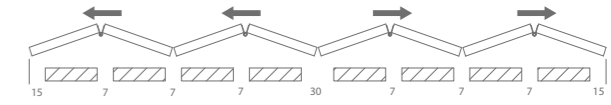

4 Shutters left - 4 Shutters right	Shutter thickness 30-34 mm	Shutter thickness 40 mm
Anodised aluminium	AM0.455.404.04	AM0.465.404.04
+ RAL of choice	on demand	on demand

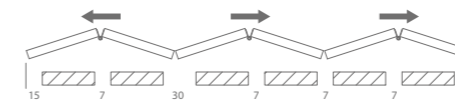

on demand	Shutter thickness 30-34 mm	Shutter thickness 40 mm
Anodised aluminium	AM0.455.402.04	AM0.465.402.04
+ RAL of choice	on demand	on demand

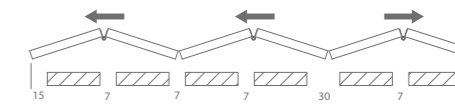

4 Shutters left - 2 Shutters right	Shutter thickness 30-34 mm	Shutter thickness 40 mm
Anodised aluminium	AM0.455.404.02	AM0.465.404.02
+ RAL of choice	on demand	on demand

\* Both versions are resistant to circumstances with high salinity, high pollution, or high contamination.

Technical drawings

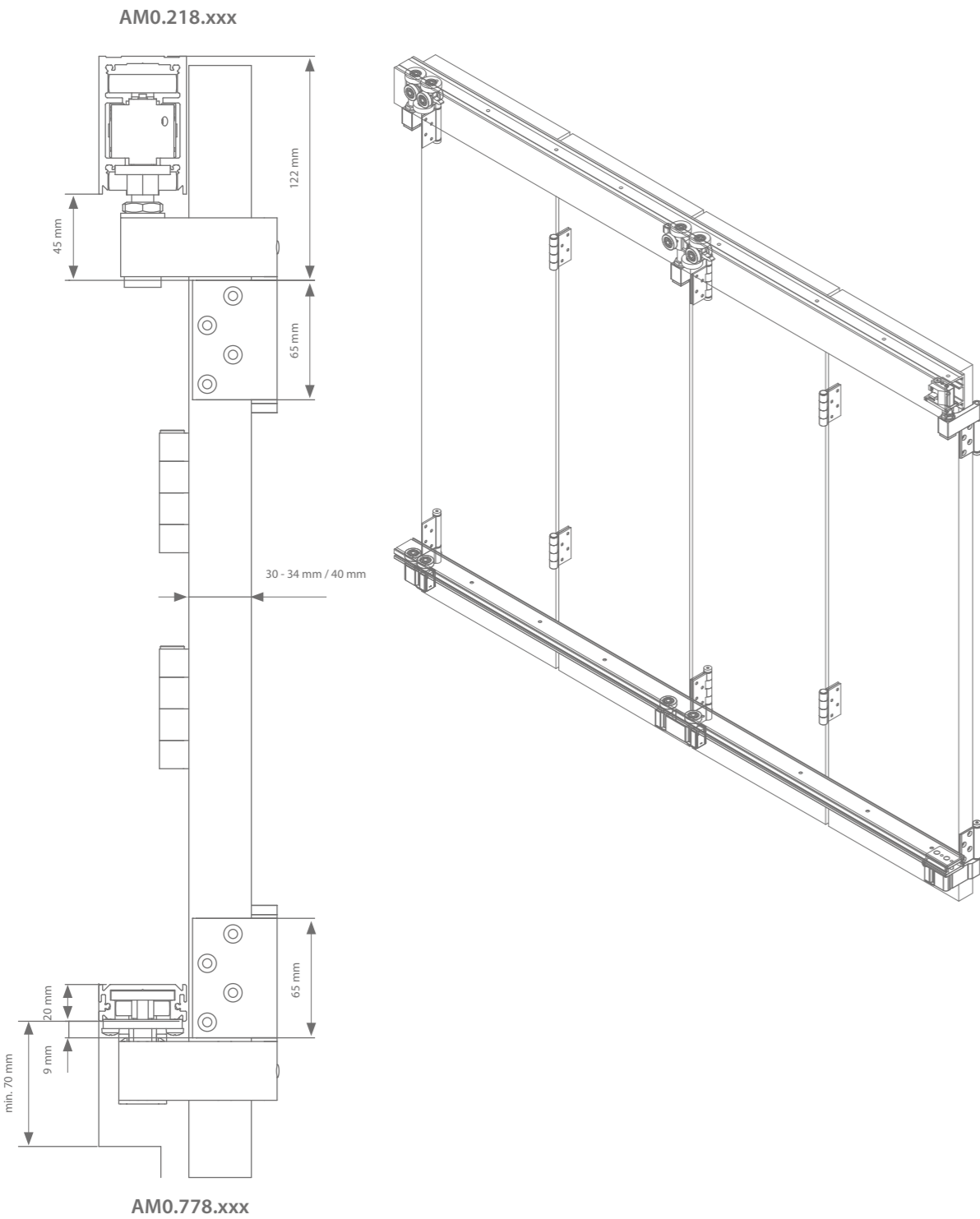

Accessories selection Shutter setup looking from the inside out

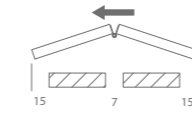

2 Shutters left	Shutter thickness 30-34 mm	Shutter thickness 40 mm
Anodised aluminium	AM0.455.602.00	AM0.465.602.00
+ RAL of choice	on demand	on demand

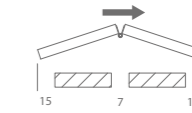

2 Shutters right	Shutter thickness 30-34 mm	Shutter thickness 40 mm
Anodised aluminium	AM0.455.600.02	AM0.465.600.02
+ RAL of choice	on demand	on demand

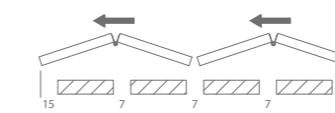

4 Shutters left	Shutter thickness 30-34 mm	Shutter thickness 40 mm
Anodised aluminium	AM0.455.604.00	AM0.465.604.00
+ RAL of choice	on demand	on demand

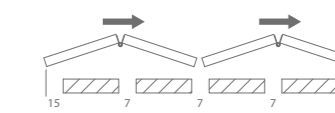

4 Shutters right	Shutter thickness 30-34 mm	Shutter thickness 40 mm
Anodised aluminium	AM0.455.600.04	AM0.465.600.04
+ RAL of choice	on demand	on demand

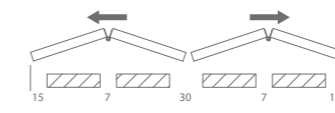

2 Shutters left - 2 Shutters right	Shutter thickness 30-34 mm	Shutter thickness 40 mm
Anodised aluminium	AM0.455.602.02	AM0.465.602.02
+ RAL of choice	on demand	on demand

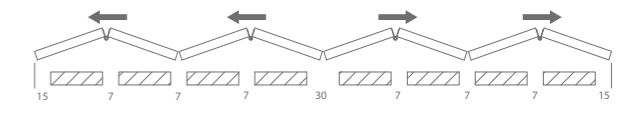

4 Shutters left - 4 Shutters right	Shutter thickness 30-34 mm	Shutter thickness 40 mm
Anodised aluminium	AM0.455.604.04	AM0.465.604.04
+ RAL of choice	on demand	on demand

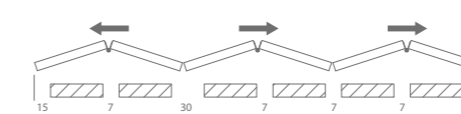

2 Shutters left - 4 Shutters right	Shutter thickness 30-34 mm	Shutter thickness 40 mm
Anodised aluminium	AM0.455.602.04	AM0.465.602.04
+ RAL of choice	on demand	on demand

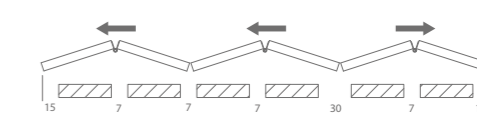

4 Shutters left - 2 Shutters right	Shutter thickness 30-34 mm	Shutter thickness 40 mm
Anodised aluminium	AM0.455.604.02	AM0.465.604.02
+ RAL of choice	on demand	on demand

\* Both versions are resistant to circumstances with high salinity, high pollution, or high contamination.



Middle hinges

	Shutter height	No. of hinges per 2 shutters	Shutter thickness	Shutter thickness
			30-34 mm	40 mm
Middle hinge (anodised)	H < 1500 mm	2	AM5.429.034	AM5.429.040
	1500 mm < H < 2400 mm	3		
	2400 mm < H < 3000 mm	4		
Middle hinge RAL of choice	H < 1500 mm	2	on demand	on demand
	1500 mm < H < 2400 mm	3		
	2400 mm < H < 3000 mm	4		

Profiles Profile length = (no. of shutters x shutter width) + sum of clearances

	Length	Untreated aluminium	Anodised alu	+ RAL of choice
Top track (Lintel mounting)	2000 mm	AM0.218.200	AM0.218.200.0	on demand
	3000 mm	AM0.218.300	AM0.218.300.0	
	4000 mm	AM0.218.400	AM0.218.400.0	
	6000 mm	AM0.218.600	AM0.218.600.0	
Bottom track (Floor mounting)	2000 mm	AM0.778.200	AM0.778.200.0	on demand
	3000 mm	AM0.778.300	AM0.778.300.0	
	4000 mm	AM0.778.400	AM0.778.400.0	
	6000 mm	AM0.778.600	AM0.778.600.0	

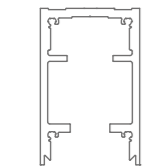

AM0.218.xxx



AM0.778.xxx



Associated locking system

All locking systems listed are required to ensure that the shutters can handle the wind load in a flat or folded position.

Shutter setup looking from the inside out	Number of locking systems required for flat position		Number of locking systems required for folded position	
	AM9.728 or AM9.725 or AM9.748.240	AM9.728.02*	AM9.738* or AM9.737*	
2R	1x	1x	1x	
2L	1x	1x	1x	
2L  2R	2x	2x	2x	
4R	2x	2x	2x	
4L	2x	2x	2x	
4L  4R	4x	4x	4x	
4L  2R	3x	3x	3x	
2L  4R	3x	3x	3x	

\* Locking mechanism AM9.728.02, AM9.738 or AM9.737 are only required if the area of the shutter exceeds 1,1m².

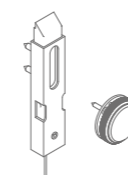

AM9.728

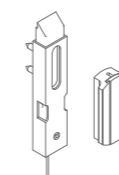

AM9.725

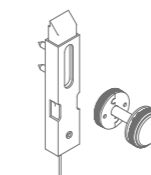

AM9.748.240  
(30-34 mm)  
AM9.748.540  
(40 mm)



AM9.728.02



AM9.738

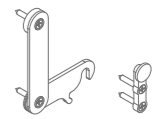

AM9.737



# 03

## HINGED SHUTTER FITTINGS

Rob® has an attractive range of shutter fittings and openers, mainly in a rustic, nostalgic style, often seen in farmhouses, cottages and nostalgic village houses

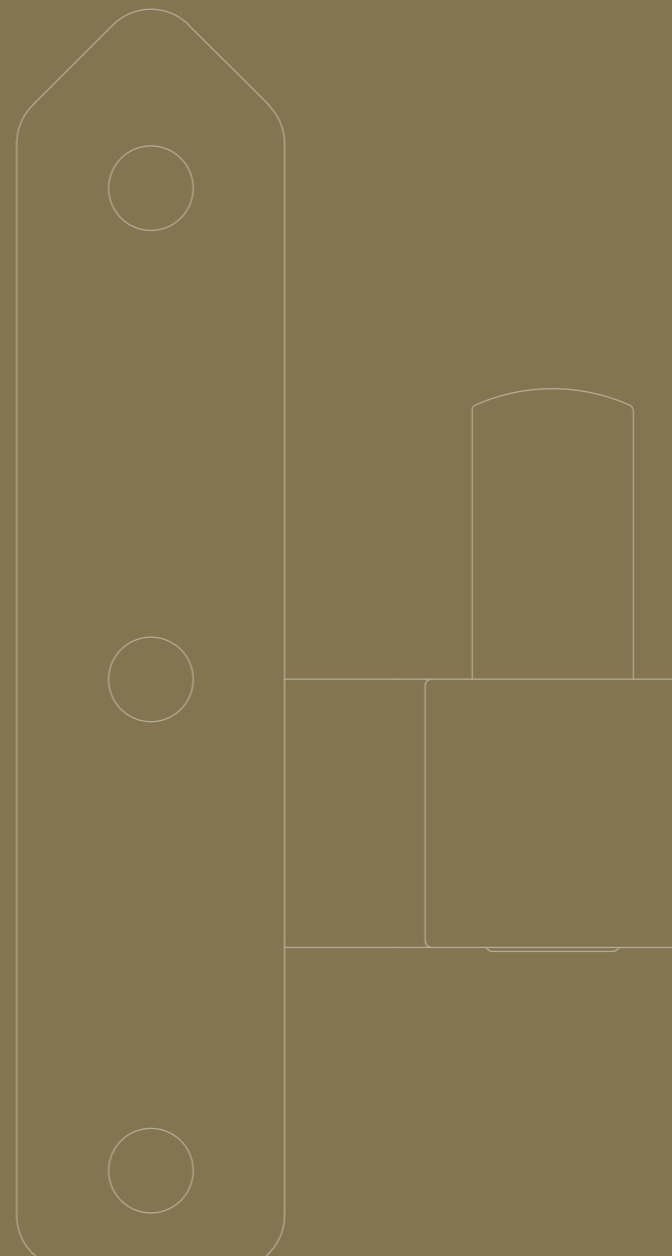



## hinged shutter fittings general information

### Materials & finishing

Stainless steel:	a stainless alloy of mainly iron, chrome, nickel and carbon
Iron:	cold-rolled iron
RAL:	powder-coated (60-70 micron) in RAL colours
BICHR:	bichromated, additional chemical surface treatment to protect steel against oxidation, after the part has been electrolytically zinc-plated. Ideal for outdoor applications.

Thickness of the products: 5 mm (unless otherwise stated).

Durability: black varnished products are first galvanised after which a powder coating (60-70 micron) is applied.

# rob HINGES

## forged hinge type 120

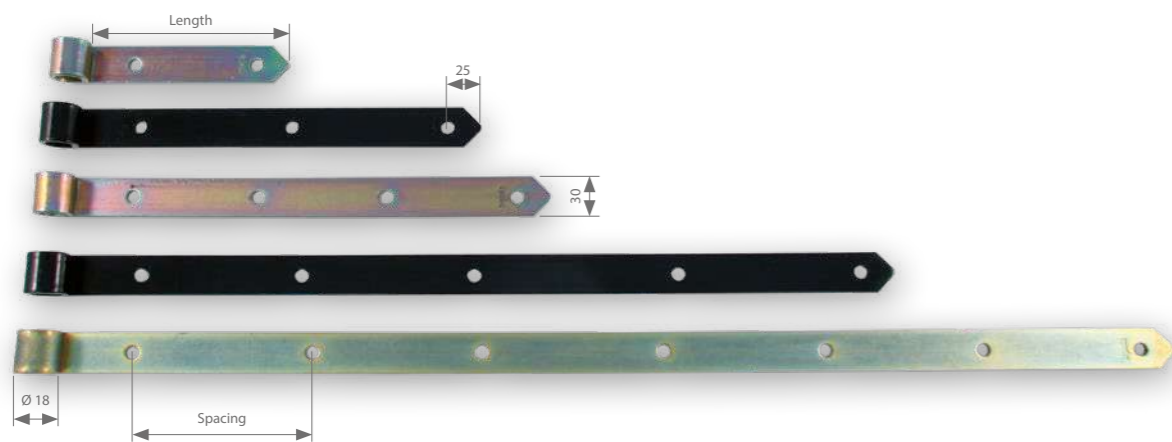

### Version

150, 200, 250, 300, 350, 400, 450, 500, 600, 700, 800 mm

### Axle diameter

Ø 18 mm

### Material

iron

### Finishing

BICHR, RAL 9005, stainless steel

### Holes

Ø 9,5 mm

### Package

50 pieces (150 till 450 mm), 25 pieces (500 till 800 mm)

Versions 200, 300 en 400 mm also available in stainless steel (per 10 pieces)

## Technical properties

Finishing	Length (mm)	Reference
BICHR	150	08120001
	200	08120002
	250	08120003
	300	08120004
	350	08120005
	400	08120006
	450	08120007
	500	08120008
	600	08120009
	700	08120010
800	08120011	
black	150	08120501
	200	08120502
	250	08120503
	300	08120504
	350	08120505
	400	08120506
	500	08120508
	600	08120509
stainless steel	200	38120002
	300	38120004
	400	38120006

## welded T hinge type 140

### Version

150, 200 mm

### Axle diameter

Ø 18 mm

### Material

iron

### Finishing

BICHR, RAL 9005, stainless steel

### Holes

Ø 9,5 mm

### Package

50 pieces

Version 150 mm available in stainless steel (per 10 pieces)

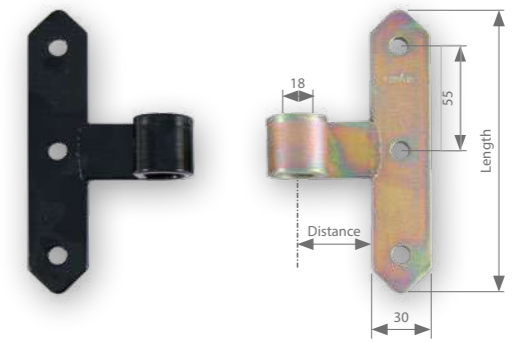

## Technical properties

Finishing	Length (mm)	Distance (mm)	Reference
BICHR	150	40	08140001
	200	55	08140002
black	150	40	08140501
	200	55	08140501
stainless steel	150	40	38140001

## welded hinge, hinge form type 141

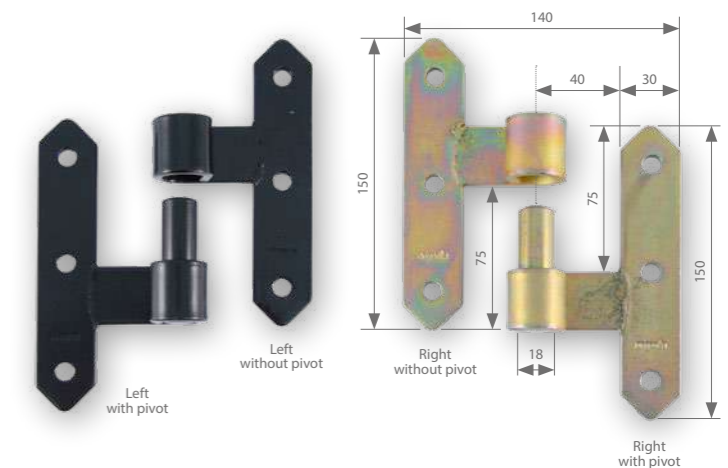

### Version

150 mm, with or without pivot, left or right model

### Axle diameter

Ø 18 mm

### Material

iron

### Finishing

BICHR, RAL 9005

### Holes

Ø 9,5 mm

### Package

25 pieces

## Technical properties

Finishing	Pivot	Direction	Reference
BICHR	Without pivot	Left	08141011
		Right	08141021
	With pivot	Left	08141013
		Right	08141023
black	Without pivot	Left	08141511
		Right	08141521
	With pivot	Left	08141513
		Right	08141523

## welded L hinge, type 150

**Version**  
200 mm, left or right model

**Axle diameter**  
Ø 18 mm

**Material**  
iron

**Finishing**  
BICHR, RAL 9005

**Holes**  
Ø 9,5 mm

**Package**  
50 pieces

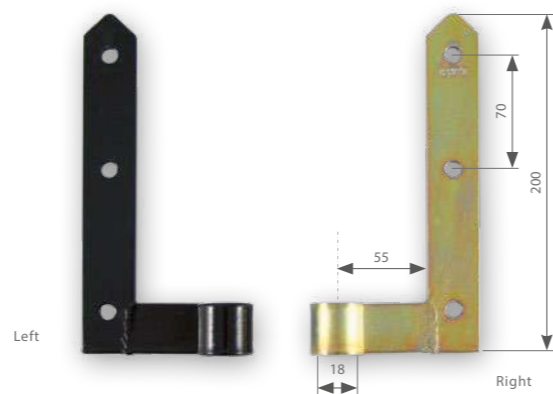

### Technical properties

Finishing	Direction	Reference
BICHR	Left	08150001
	Right	08150002
black	Left	08150501
	Right	08150502

## corner hinge, type 151

**Version**  
350 mm, left or right model

**Axle diameter**  
Ø 18 mm

**Material**  
iron

**Finishing**  
BICHR, RAL 9005

**Holes**  
Ø 7 mm

**Package**  
25 pieces

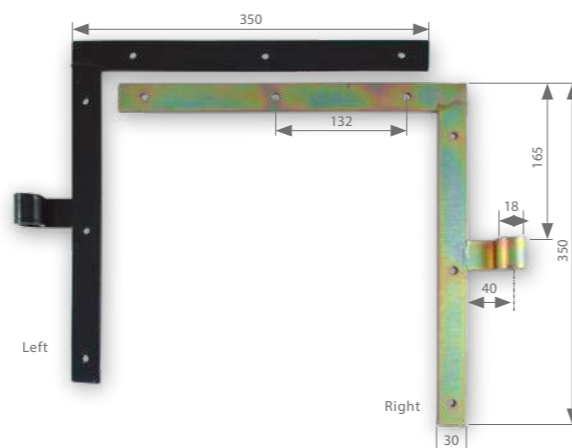

### Technical properties

Finishing	Direction	Reference
BICHR	Left	08151011
	Right	08151021
black	Left	08151511
	Right	08151521

## rob PINTELS

### pintel for concrete walls type 111

**Axle diameter**  
Ø 18 mm

**Material**  
iron

**Finishing**  
BICHR, RAL 9005

**Package**  
50 pieces

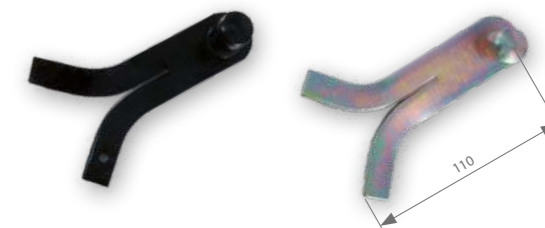

### Technical properties

Finishing	Reference
BICHR	08111001
black	08111501

### pintel for stone walls, type 115

**Axle diameter**  
Ø 18 mm

**Material**  
iron

**Finishing**  
BICHR, RAL 9005

**Package**  
50 pieces

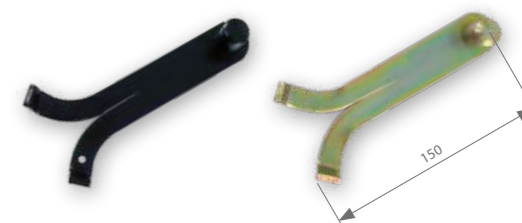

### Technical properties

Finishing	Reference
BICHR	08115001
black	08115501

### pintel, screw form type 112

**Axle diameter**  
Ø 18 mm

**Screw diameter**  
Ø 10 mm

**Material**  
iron

**Finishing**  
BICHR, RAL 9005, stainless steel

**Package**  
50 pieces  
Also available in stainless steel (per 10 pieces)

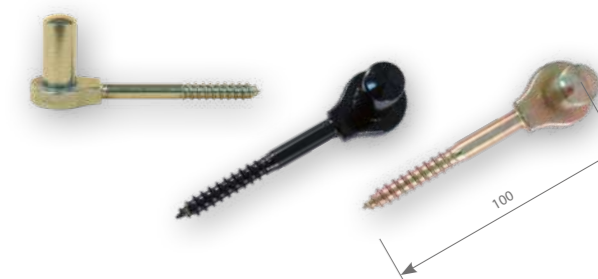

### Technical properties

Finishing	Reference
BICHR	08112001
black	08112501
stainless steel	38112001

## pintel, small model type 160/1

### Axle diameter

Ø 18 mm

### Width/thickness

30 mm / 3 mm

### Material

iron

### Finishing

BICHR, RAL 9005, stainless steel

### Holes

Ø 9,5 mm

### Package

50 pieces

Also available in stainless steel (per 10 pieces)

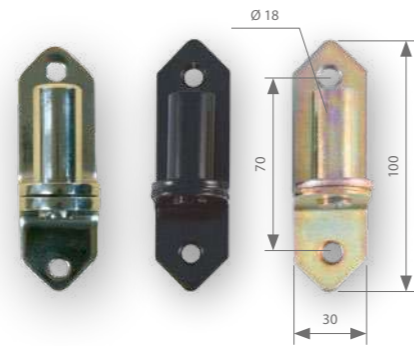

### Technical properties

Finishing	Reference
BICHR	08160001
black	08160501
stainless steel	38160001

## pintel, large model type 160/2

### Axle diameter

Ø 18 mm

### Width/thickness

40 mm / 4 mm

### Material

iron

### Finishing

BICHR, RAL 9005, stainless steel

### Holes

Ø 9,5 mm

### Package

50 pieces

Also available in stainless steel (per 10 pieces)

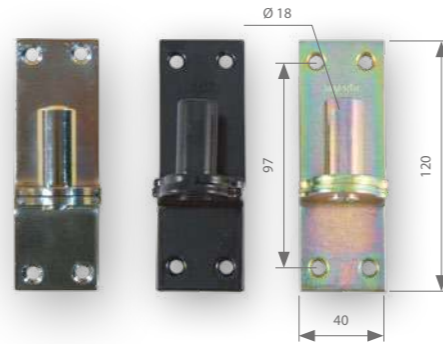

### Technical properties

Finishing	Reference
BICHR	08160002
black	08160502
stainless steel	38160002

## separate pivot type 114

### Axle diameter

Ø 18 mm

### Material

iron

### Finishing

BICHR, RAL 9005

### Package

50 pieces

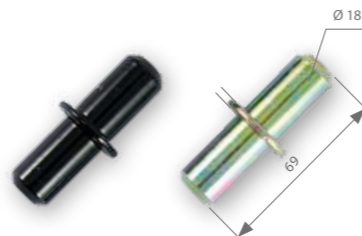

### Technical properties

Finishing	Reference
BICHR	08114001
black	08114501

## rob SHUTTER DOGS

### screw shutter dog type 113

### Version

100, 150 mm

### Screw diameter

Ø 10 mm

### Material

iron

### Finishing

BICHR, RAL 9005

### Package

25 pieces

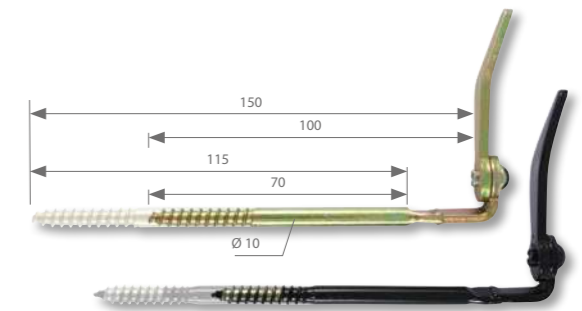

### Technical properties

Finishing	Length (mm)	Reference
BICHR	100	08113001
	150	08113002
black	100	08113501
	150	08113502

### shutter dog shepherdess head type 116

### Version

120, 170 mm

### Screw diameter

Ø 10 mm

### Material

iron

### Finishing

BICHR, RAL 9005

### Package

per 10 pieces

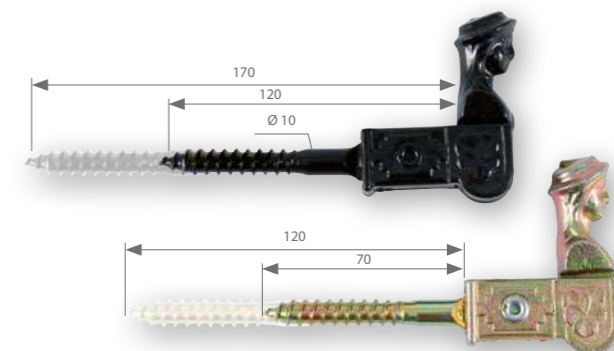

### Technical properties

Finishing	Length (mm)	Reference
BICHR	120	08116101
	170	08116102
black	120	08116001
	170	08116002

rob  
**BOLTS**

lock bolt type 131

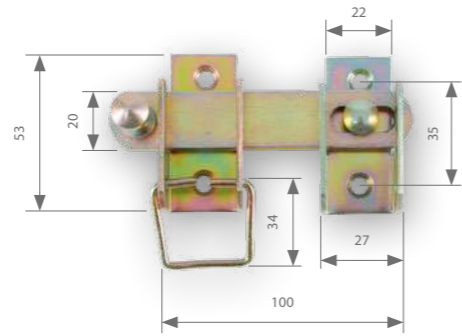

**Material**  
iron

**Finishing**  
BICHR, RAL 9005

**Holes**  
Ø 5,5 mm

**Package**  
25 pieces

Technical properties

Finishing	Reference
BICHR	08131001
black	08131501

rob  
**STABLE RING**

stable ring type 128

**Length**  
85 mm

**Ring diameter**  
75 mm

**Material**  
iron

**Finishing**  
BICHR, RAL 9005

**Package**  
25 pieces

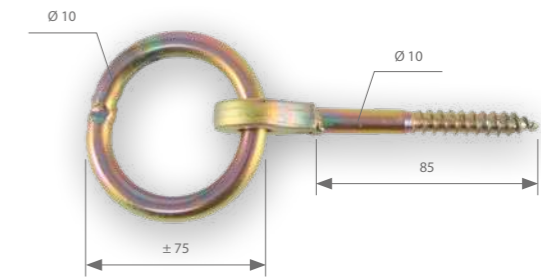

Technical properties

Finishing	Reference
BICHR	08128001

stable ring type 129

**Length**  
85 mm

**Ring diameter**  
75 mm

**Screw thread**  
M10

**Material**  
iron

**Finishing**  
BICHR, RAL 9005

**Package**  
25 pieces

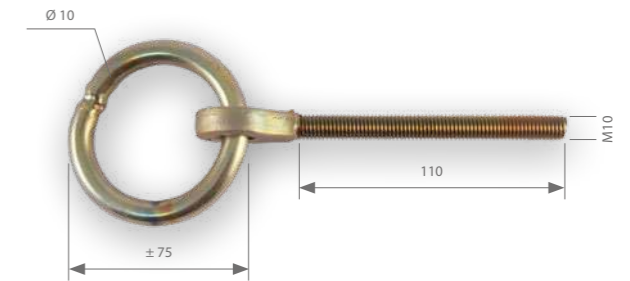

Technical properties

Finishing	Reference
BICHR	08129001

stable ring type 130

**Length**  
85 mm

**Ring diameter**  
75 mm

**Material**  
iron

**Screw thread**  
M12

**Finishing**  
BICHR, RAL 9005

**Package**  
25 pieces

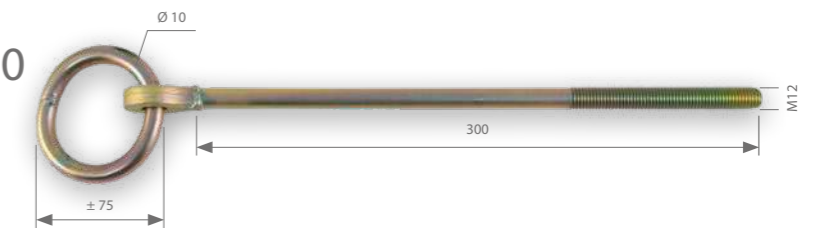

Technical properties

Finishing	Reference
BICHR	08130001

# NOTES

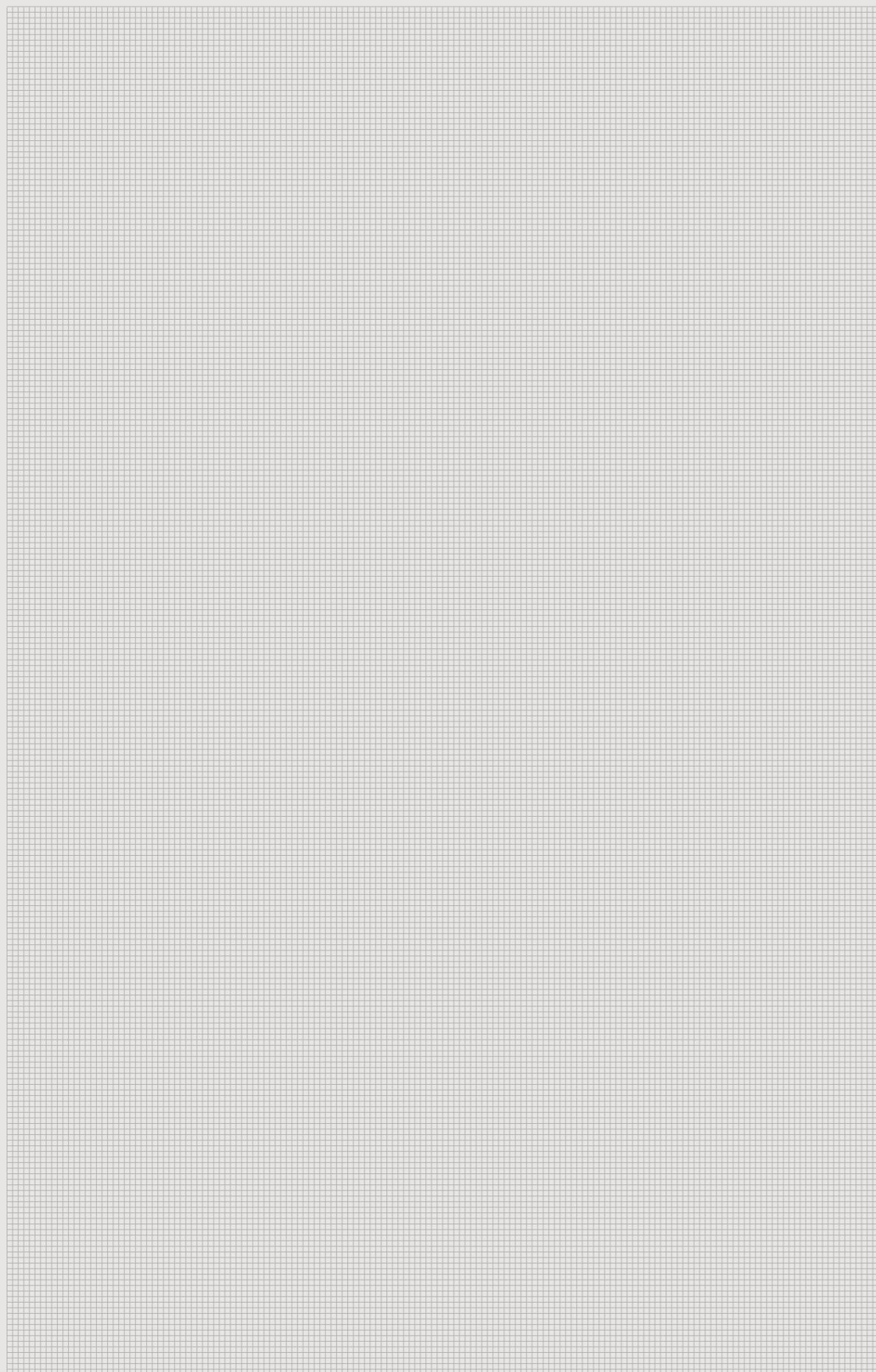

# NOTES

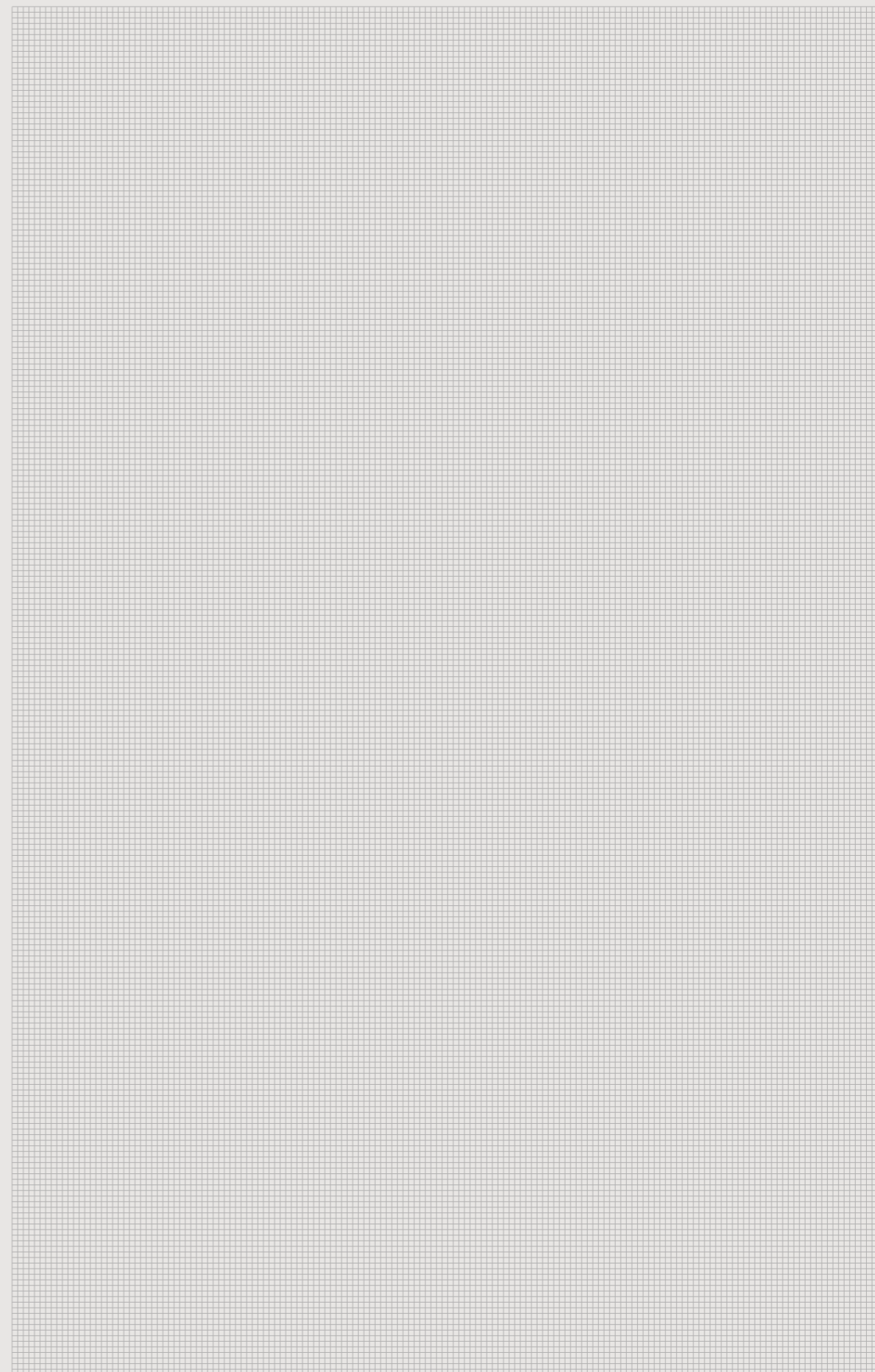



Ter Vlucht 2 +32 (0)51 27 05 00  
8850 Ardoonie info@arlu.be  
Belgium WWW.ARLU.BE



©L300034 11/23 English